

# LPC24-P1

- [1] Contents
- [2] Reserved
- [3] uC (LPC2478)
- [4] User-Interface
- [5] Power
- [6] SRAM

This document may not be passed on, duplicated or its contents utilized, unless expressly permitted. Violating this stipulation will result in the liability to pay damages. All rights reserved in case of a patent registration or registered design.

P1 / 26.05.2008 / BI	Contents
<b>hitex</b>	LPC24-P1
DEVELOPMENT TOOLS	11.12.2008 16:41:16
	Sheet: 1/6

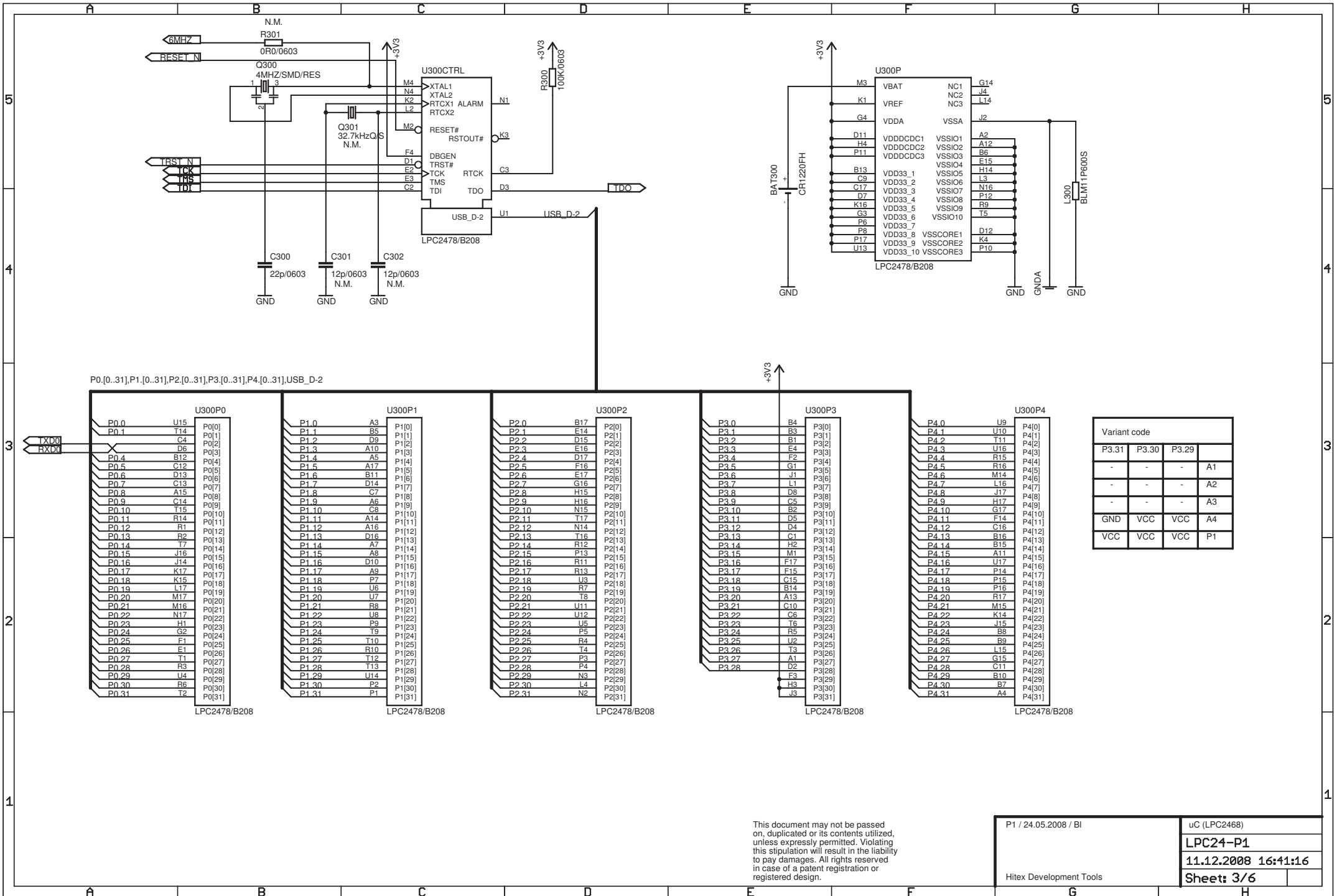

Variant code			
P3.31	P3.30	P3.29	
-	-	-	A1
-	-	-	A2
-	-	-	A3
GND	VCC	VCC	A4
VCC	VCC	VCC	P1

This document may not be passed on, duplicated or its contents utilized, unless expressly permitted. Violating this stipulation will result in the liability to pay damages. All rights reserved in case of a patent registration or registered design.

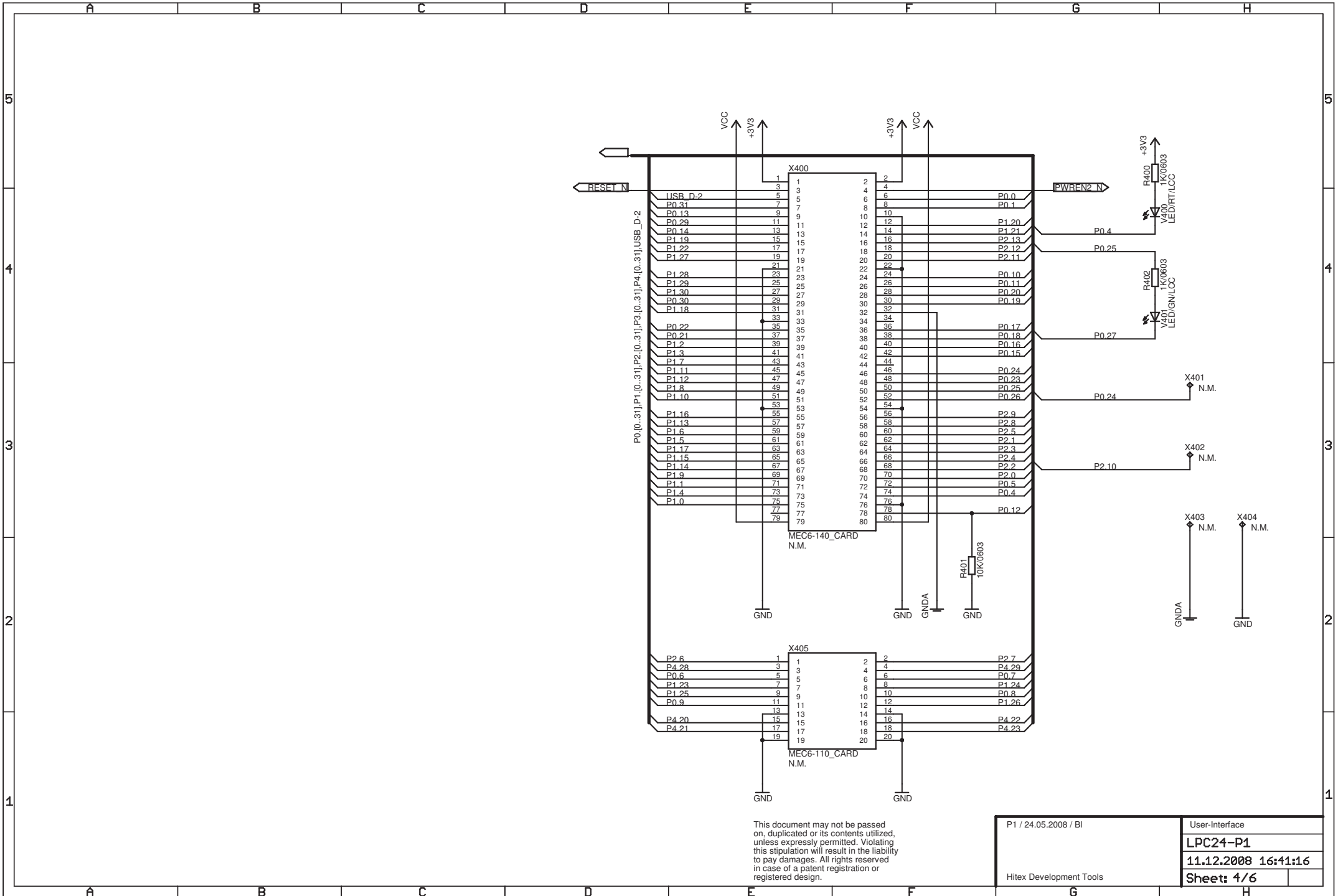

This document may not be passed on, duplicated or its contents utilized, unless expressly permitted. Violating this stipulation will result in the liability to pay damages. All rights reserved in case of a patent registration or registered design.

P1 / 24.05.2008 / BI

User-Interface

LPC24-P1

11.12.2008 16:41:16

Hiltek Development Tools

Sheet: 4/6

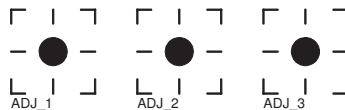
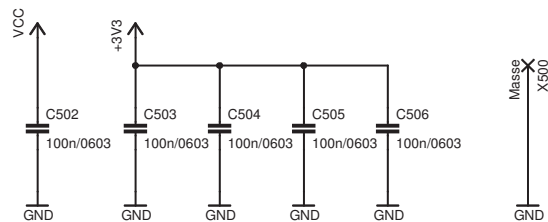
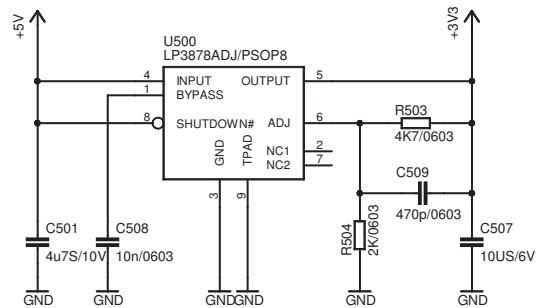
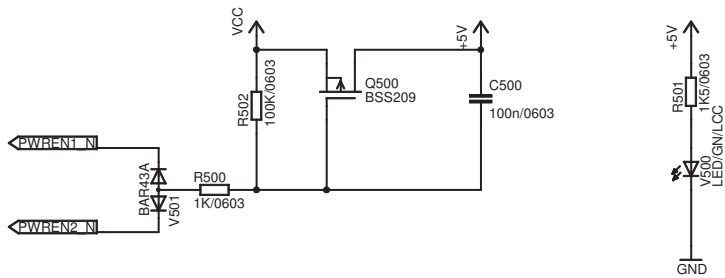

This document may not be passed on, duplicated or its contents utilized, unless expressly permitted. Violating this stipulation will result in the liability to pay damages. All rights reserved in case of a patent registration or registered design.

P1 / 24.05.2008 / BI	Power
LPC24-P1	
11.12.2008 16:41:16	
Hitex Development Tools	Sheet: 5/6

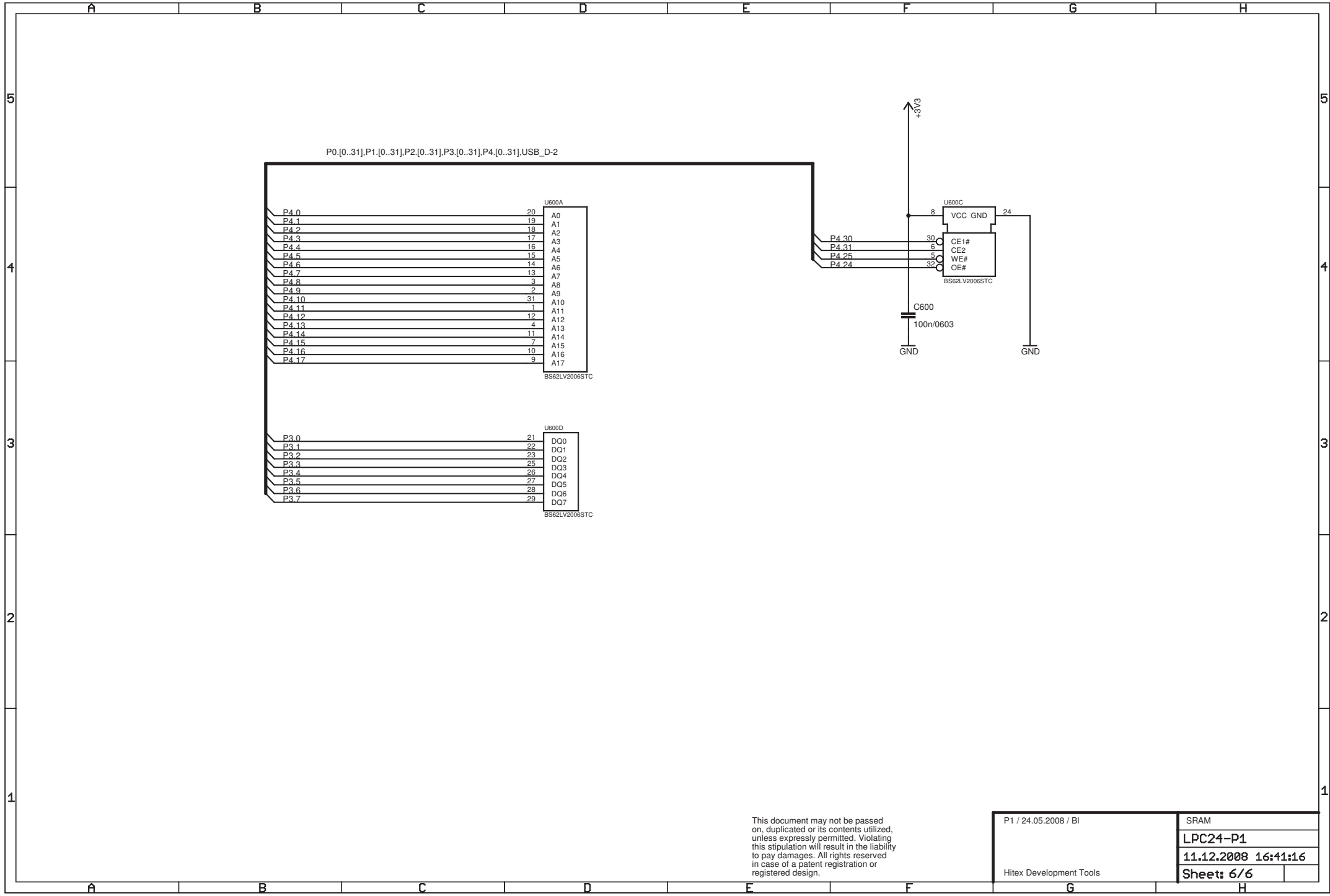

This document may not be passed on, duplicated or its contents utilized, unless expressly permitted. Violating this stipulation will result in the liability to pay damages. All rights reserved in case of a patent registration or registered design.

P1 / 24.05.2008 / BI

Hilux Development Tools

SRAM

LPC24-P1

11.12.2008 16:41:16

Sheet: 6/6