

**WORLD  
CROSSBOW  
SHOOTING  
ASSOCIATION**

***MEDIEVAL CROSSBOW  
SHOOTING RULES***

**April 2007**

# INDEX

Clause	Item	Page No
<b>INDEX</b>		<b>M 3</b>
<b>SECTION 1.</b>	<b>WORLD CHAMPIONSHIPS, RECORDS, ASSISTED SHOOTERS</b>	
1	PRECEDENCE, INTERPRETATION AND AMENDMENTS	M 7
2	WORLD CHAMPIONSHIPS	M 7
3	REGIONAL CHAMPIONSHIPS	M 8
4	WORLD CROSSBOW SHOOTING ASSOCIATION STAR TOURNAMENTS	M 8
5	RIGHTS OF PARTICIPATION AND CITIZENSHIP	M 8
	5.2 Eligibility	M 8
	5.3 Divisions	M 9
	5.5 Guest Competitors	M 9
6	ELIGIBILITY CODE	M 9
7	PROGRAMME, OFFICIAL FUNCTIONS AND CEREMONIES	M 9
	7.1 Program	M 9
	7.2 Reception	M 10
	7.3 Opening Ceremony	M 10
	7.4 Awards Ceremony	M 10
	7.5 Distribution of Special Prizes/Awards	M 10
	7.6 Closing Ceremony	M 10
	7.7 Farewell Function	M 10
8	DRESS REGULATIONS	M 10
9	ACCREDITATION	M 10
10	CHAMPIONSHIP DOCUMENTS	M 10
11	TEAM AND INDIVIDUAL COMPETITIONS	M 11
	11.2 Team Competitions	M 11
	11.3 Substitute Competitors	M 11
	11.4 Individual Competitors	M 11
12	TARGET ASSIGNMENT	M 11
	12.1 Outdoor and Indoor target	M 11
	12.2 Forest and 3D	M 12
13	COMPETITOR NUMBERS	M 12
14	OFFICIAL COMMUNICATION	M 12
15	EQUAL SHOOTING CONDITIONS	M 12
16	MEDALS, TROPHIES AND PERFORMANCE AWARDS	M 12
	16.1 Medals	M 12
	16.2 Prizes and Trophies	M 13
17	TEAM OFFICIALS	M 13
18	INDIVIDUAL COMPETITORS	M 13
19	TECHNICAL DELEGATE	M 13
20	JURY OF APPEAL	M 14
	20.5 Protest Fee	M 14
21	DISCIPLINARY ACTION	M 14
22	DOPING CONTROL	M 14
	22.2 Doping	M 14
	22.4 Medical Provisions	M 14
	22.5 Competitors Declaration	M 14
	22.6 Officials Declaration	M 14
	22.7 Medical Tests	M 14
	22.8 Drug Test Results	M 15
23	DIRECTOR OF SHOOTING	M 15
24	TOURNAMENT JUDGE COMMISSION	M 15
25	EQUIPMENT SCRUTINEERING AND CONTROL	M 15
26	SCORING	M 15
	26.1 Outdoor and Indoor target	M 15
	26.2 Forest and 3D	M 16
27	PRACTICE	M 16
28	WORLD CHAMPIONSHIP TITLES	M 17
	28.2 Outdoor Target	M 17
	28.3 Outdoor Match-play	M 17
	28.4 Indoor Target	M 17
	28.5 Indoor Match-play	M 18
	28.6 Forest Round	M 18
	28.7 3D Round	M 18
29	WORLD CHAMPIONSHIP ROUNDS	M 19
	29.1 Outdoor Target	M 19
	29.2 Outdoor Match-play	M 19
	29.3 Indoor Target	M 19
	29.4 Indoor Match-play	M 19
	29.5 Forest Round	M 20
	29.6 3D Round	M 20
30	WORLD RECORDS	M 20
	30.1 Types	M 20
	30.2 Definition	M 20
	30.3 World Records	M 20
	30.4 Tournaments	M 21
	30.5 Confirmation of World Records	M 21
	30.6 Publication of Records	M 21

Clause	Item	Page No
31	ASSISTED SHOOTERS .....	M 21
	31.1 General .....	M 21
	31.2 Championships .....	M 21
	31.3 Teams .....	M 21
	31.4 Shooting Position .....	M 21
	31.5 Assisted Shooter .....	M 21
<b>SECTION 2. SAFETY, MEDIEVAL CROSSBOW, BOLTS &amp; CLOTHING</b>		
32	A COMPETITORS RESPONSIBILITY FOR SAFETY .....	M 24
33	MEDIEVAL CROSSBOW EQUIPMENT .....	M 24
34	BOLT SPECIFICATIONS .....	M 25
35	CLOTHING .....	M 25
<b>SECTION 3. OUTDOOR TARGET &amp; OUTDOOR MATCHPLAY</b>		
36	OUTDOOR TARGET .....	M 27
	36.1 Range Layout .....	M 27
	36.2 Venue Equipment .....	M 27
	36.3 Target Faces .....	M 28
	36.4 Time Control Equipment .....	M 28
	36.5 Miscellaneous Equipment .....	M 29
	36.6 Shooting Control and Safety .....	M 29
	36.7 Order of Shooting and Timing Control .....	M 30
	36.8 Shooting .....	M 30
	36.9 Scoring .....	M 31
	36.10 Ties .....	M 32
	36.11 Questions Disputes and Appeals .....	M 32
	36.12 Jury of Appeal .....	M 33
	36.13 Director of Shooting .....	M 33
	36.14 Judges .....	M 33
37	OUTDOOR MATCH-PLAY .....	M 34
	37.9 Range Layout .....	M 34
	37.10 Venue Equipment .....	M 35
	37.11 Target Faces .....	M 35
	37.12 Time Control Equipment .....	M 35
	37.13 Miscellaneous Equipment .....	M 35
	37.14 Shooting Control and Safety .....	M 36
	37.15 Order of Shooting and Timing Control .....	M 36
	37.16 Shooting .....	M 37
	37.17 Scoring .....	M 37
	37.18 Ties .....	M 38
	37.19 Questions Disputes and Appeals .....	M 38
	37.20 Jury of Appeal .....	M 38
	37.21 Director of Shooting .....	M 38
	37.22 Judges .....	M 39
SCHEDULE 1 OUTDOOR TARGET ROUNDS .....		M 39
<b>SECTION 4. FOREST ROUND</b>		
38	THE RANGE .....	M 41
	38.1 Course Layout .....	M 41
	38.2 Miscellaneous Equipment .....	M 41
	38.3 Shooting Control and Safety .....	M 41
	38.4 Order of Shooting and Timing Control .....	M 42
	38.5 Target Faces and Distances .....	M 42
	38.6 Shooting .....	M 43
	38.7 Scoring .....	M 43
	38.8 Ties .....	M 44
	38.9 Questions Disputes and Appeals .....	M 44
	38.10 Jury of Appeal .....	M 45
	38.11 Course Director .....	M 45
	38.12 Judges .....	M 45
<b>SECTION 5. 3D ROUND</b>		
39	THE RANGE .....	M 48
	39.1 Course Layout .....	M 48
	39.2 Miscellaneous Equipment .....	M 48
	39.3 Shooting Control and Safety .....	M 48
	39.4 Order of Shooting and Timing Control .....	M 49
	39.5 Target Faces and Distances .....	M 49
	39.6 Shooting .....	M 50
	39.7 Scoring .....	M 50
	39.8 Ties .....	M 51
	39.9 Questions Disputes and Appeals .....	M 51
	39.10 Jury of Appeal .....	M 52
	39.11 Course Director .....	M 52
	39.12 Judges .....	M 52

Clause	Item	Page No
<b>SECTION 6 APPENDIX/DIAGRAMS</b>		
	Appendix 1 - Typical Medieval Crossbow .....	M 55
	Appendix 2 - Sample Medieval Trigger .....	M 55
	Appendix 3 - Recommended Outdoor Target Ground Layout for World Championships .....	M 56
	Appendix 4 - Target Butt .....	M 56
	Appendix 5 - Wind Indicator .....	M 57
	Appendix 6 - 30 Second Timer Board .....	M 57
	Appendix 7 - Target Face (Multi Colour) .....	M 58
	Appendix 8 - Recommended Outdoor Match-Play Ground Layout for World Championships.....	M 58
	Appendix 9 - Matchplay Chart .....	M 59
	Appendix 10 - Assisted Shooters Crossbow Support Picture .....	M 60
	Appendix 11 - Assisted Shooters Crossbow Support Diagram .....	M 60

# **SECTION ONE**

## **World Championships**

### **Records**

#### **Assisted Shooters**

## 1 PRECEDENCE, INTERPRETATION AND AMENDMENTS

- 1.1 Amendments to these Rules can only be made in accordance with the World Crossbow Shooting Association Constitution.
- 1.2 The general interpretation and maintenance of these rules shall be the responsibility of the Technical Committee.
- 1.3 For any special exceptions to the above rules the permission of the Executive of the World Crossbow Shooting Association must be obtained.
- 1.4 In cases of difficulties arising out of differences in the interpretation of these rules, the original English text shall prevail. If there is a conflict between these rules and the World Crossbow Shooting Association Constitution, the latter shall take precedence.
- 1.5 Gender: References to the male gender shall import the female gender and conversely, except where the context indicates that the matter is gender-specific.

## 2 WORLD CHAMPIONSHIPS

World Crossbow Shooting Association will arrange for the organisation of the following:

### 2.1 Outdoor Target

2.1.1 There will be a World Crossbow Shooting Association Medieval Crossbow World Outdoor Target Championships for Women, Men, Junior Girls, Junior Boys, Senior Women, Senior Men, Assisted Women and Assisted Men Competitors which will be decided on a **Double MC600 Round** shot one round per day over two (2) days of competition. Day one (1) distances to be shot in the order of 40m, 30m, 20m. Day two (2) will be in the order 20m, 30m, 40m.

2.1.2 There will be a World Crossbow Shooting Association Medieval Crossbow World Outdoor Match-play Championships for Women, Men, Junior Girls, Junior Boys, Senior Women, Senior Men, Assisted Women and Assisted Men Competitors, which will be decided on a Match-play Event shot after the Target Event.

2.1.3 There will be a World Crossbow Shooting Association Medieval Crossbow Guest World Outdoor Target Championships for both Women and Men for all Medieval Crossbow shooters who are not members of the World Crossbow Shooting Association. It will be decided on a **Double MC600 Round** shot one round per day over two (2) days of competition. Day one (1) distances to be shot in the order of 40m, 30m, 20m. Day two (2) will be in the order 20m, 30m, 40m.

2.1.4 There will be a World Crossbow Shooting Association Medieval Crossbow Guest World Outdoor Match-play Championships for both Women and Men who are not members of the World Crossbow Shooting Association. It will be decided on a Match-play Event shot after the Target Event.

2.1.5 The World Outdoor Target Championships will take place every two (2) years during odd years and will be held in conjunction with the World Crossbow Shooting Association Target Crossbow World Outdoor Target Championships unless special dispensation for it to be held separately has been granted by the World Crossbow Shooting Association Executive.

### 2.2 Indoor Target

2.2.1 There will be a World Crossbow Shooting Association Medieval Crossbow World Indoor Target Championships for Women, Men, Junior Girls, Junior Boys, Senior Women, Senior Men, Assisted Women and Assisted Men Competitors, which will be decided on an Indoor 600/40 and an Indoor 600/25 Round shot one round per day over two (2) days of competition. The Indoor 600/40 will be shot on day one and the Indoor 600/25 on day two.

2.2.2 There will be a World Crossbow Shooting Association Medieval Crossbow World Indoor Match-play Championships for Women, Men, Junior Girls, Junior Boys, Senior Women, Senior Men, Assisted Women and Assisted Men Competitors, which will be decided on a Match-play Event shot after the Indoor Target Event.

2.2.3 There will be a World Crossbow Shooting Association Medieval Crossbow Guest World Indoor Target Championships for both Women and Men for all crossbow shooters who are not members of the World Crossbow Shooting Association. It will be decided on an Indoor 600/40 and an Indoor 600/25 Round shot one round per day over two (2) days of competition. The Indoor 600/40 will be shot on day one and then Indoor 600/25 on day two.

2.2.4 There will be a World Crossbow Shooting Association Medieval Crossbow Guest World Indoor Match-play Championships for both Women and Men are not members of the World Crossbow Shooting Association. It will be decided on a Match-play Event shot after the Target Event.

2.2.5 The World Indoor Target Championships will take place as frequently as required but not closer than two (2) years apart and must be conducted during even years in conjunction with the World Crossbow Shooting Association Target Crossbow World Indoor Target Championships unless special dispensation for it to be held separately has been granted by the World Crossbow Shooting Association Executive.

2.2.6 The Executive of the World Crossbow Shooting Association may conduct the World Indoor Target Championships as a Postal Shoot Event to enable all members to participate should the need arise. A Postal World Indoor Target Championships will not include a Match-play Championships.

### 2.3 Forest

2.3.1 There will be a World Crossbow Shooting Association Medieval Crossbow World Forest Championships for Women, Men, Junior Girls, Junior Boys, Senior Women, Senior Men, Assisted Women and Assisted Men Competitors, which will be decided on a 48 Unmarked Round shot 24 Targets per day over two (2) days of competition.

2.3.2 There will be a World Crossbow Shooting Association Medieval Crossbow Guest World Forest Championships for both Women and Men for all crossbow shooters who are not members of the World Crossbow Shooting Association. It will be decided on a 48 Unmarked Round shot 24 Targets per day over two (2) days of competition.

2.3.3 The World Forest Championships will take place every two (2) years during odd years and will be held in conjunction with the World Crossbow Shooting Association Target Crossbow World Outdoor Target Championships unless special dispensation for it to be held separately has been granted by the World Crossbow Shooting Association Executive.

### 2.4 3D

2.4.1 There will be a World Crossbow Shooting Association Medieval Crossbow World 3D Championships for Women, Men, Junior Girls, Junior Boys, Senior Women, Senior Men, Assisted Women and Assisted Men Competitors, which will be decided on a double 3D Round shot one round per day over two (2) days of competition.

- 2.4.2 There will be a World Crossbow Shooting Association Medieval Crossbow Guest World 3D Championships for both Women and Men for all crossbow shooters who are not members of the World Crossbow Shooting Association. It will be decided on a Double 3D Round shot one round per day over two (2) days of competition.
- 2.4.3 The World 3D Championships will take place every two (2) years during odd years and will be held in conjunction with the World Crossbow Shooting Association Target Crossbow World Outdoor Target Championships unless special dispensation for it to be held separately has been granted by the World Crossbow Shooting Association Executive.
- 2.5 Federations desirous of hosting a World Championship must prepare a formal written proposal to the Executive of the World Crossbow Shooting Association.
- 2.6 In the written proposal:
- Consideration must be made for full teams from all Member Federation, Individual Members as well as competitors who are not members of the World Crossbow Shooting Association. The venue details as to the size and location, number of targets/competitors, shooting direction and safety.
  - Availability of accommodation, transport and administrative support arrangements.
  - A detailed budget including sponsorship, government support, manpower, officials, experience of the Organisers, etc.
- 2.7 Such presentations shall be voted upon by the Executive.
- 2.8 World Championships shall be conducted in accordance with these Rules.
- 2.9 At a World Championships there must be at least five (5) Member Federations represented and/or 50 Individual Members competing unless special dispensation is granted by the Executive.

### 3 REGIONAL CHAMPIONSHIPS

- 3.1 Regions may arrange for the organisation of their own Regional Championships.
- 3.2 The Regional Championships
- may take place every two (2) years, but not more frequently.
  - must be notified to and registered with the World Crossbow Shooting Association.
  - must not have conflicting dates with World Championships. As a guide, Regional Championships should be held in even years.
  - shall be conducted in accordance with the World Crossbow Shooting Association Rules.
  - there must be at least three (3) Member Federations represented and/or 30 Individual Members competing unless special dispensation is granted by the Executive.
- 3.3 A Member Federation may belong to only one Region. If its Territory is situated in more than one area, or in a border area, or for any other serious reason/s it may choose the Region to which it will belong. The Region chosen must be notified to World Crossbow Shooting Association three (3) months prior to it taking effect.
- 3.4 Regions shall be as determined by the World Crossbow Shooting Association Council from time to time.

### 4 WORLD CROSSBOW SHOOTING ASSOCIATION STAR TOURNAMENTS

- 4.1 Star Tournaments are those tournaments which may be conducted by a Member Federation for the purposes of awarding individual achievement performances. Star Tournaments shall be registered with the World Crossbow Shooting Association, preferably 6 months prior to the conduct of the event.
- 4.2 The registration fee and purchase price of the World Crossbow Shooting Association Star Badges will be set by the World Crossbow Shooting Association Executive.
- 4.3 World Crossbow Shooting Association Stars are claimable for the following scores when they are achieved,  
Outdoor Target: for MC600 - 400, 450, 500, 540, 550, 560, 570, 580, 590, 600  
Indoor Target: for Indoor 600/25 - 450, 500, 540, 570, 580, 590, 600  
Indoor Target: for Indoor 600/40 - 450, 500, 540, 570, 580, 590, 600
- 4.4 All World Crossbow Shooting Association World and Regional Championships are automatically registered as World Crossbow Shooting Association Star Tournaments
- 4.5 Conditions to claim a World Crossbow Shooting Association Star:
- It must be at a World Crossbow Shooting Association Star Registered Tournament and shot to World Crossbow Shooting Association shooting Rules.
  - The tournament must be registered and any fees paid before the tournament takes place.
  - World Crossbow Shooting Association Stars can only be purchased from the World Crossbow Shooting Association by paying the purchase price.
  - Member Federations may purchase bulk quantities from the World Crossbow Shooting Association to hold in stock

### 5 RIGHTS OF PARTICIPATION AND CITIZENSHIP

- 5.1 Only teams and individuals who belong to a Member Federation which is a Financial Member or Individuals who are Financial Members (either directly or as members of a Members Club) of the World Crossbow Shooting Association shall participate for positions and awards in World Crossbow Shooting Association sanctioned events unless an invitation to participate in a Guest Event is extended by the World Crossbow Shooting Association to Organisations or individuals who are not Members of the World Crossbow Shooting Association.
- 5.2 **Eligibility**
- 5.2.1 To be eligible to participate as a Member of a National Team in World Crossbow Shooting Association sanctioned events, a competitor must have in his possession a valid passport from the country of which he is a National Team Member; or if he is to be a Member of another National Team he must have resided in the new country for at least one year and must have the written permission of the Member Federation, if any, of the country from which he has a valid passport. Nationals of the host Federation who do not have a valid passport, must provide alternative proof of



Citizenship or Residency to the satisfaction of the International Judges.

- 5.2.2 The submission of entry forms implies a declaration
- a) For World Crossbow Shooting Association Members  
that the Individual Member or Member Federation or Member Club is financial and in good standing with the World Crossbow Shooting Association and that the Individual Member expenses will be covered by themselves and that all competitors and or officials expenses will be covered by the respective Member Federation in case of illness or accident. Should this not be the case then those Individual Members or Member Federations will not be permitted to compete in the Championships.
  - b) For Non members of the World Crossbow Shooting Association  
that the Individual Competitor, Competitor's Association, Competitors Club and/or Official/s is financially viable and that in case of illness or accident the Individual Competitor's and/or Official/s expenses will be covered by the Individual Competitor, the Competitors' Association, Competitors' Club and/or the Official/s. Should this not be the case then those Individual Competitors, Competitors Associations or Competitors Club and/or Official/s will not be permitted to compete in the Championships.
- 5.2.3 Team officials participating in the Championships must abide by these Rules.
- 5.2.4 For Team entries refer to clause 11.2.

### 5.3 Divisions

- 5.3.1 **WCSA WOMEN:** For female competitors of any age who are World Crossbow Shooting Association Members who cannot or do not want to enter the groups listed in 5.3.3, 5.3.5 and 5.3.7.
- 5.3.2 **WCSA MEN:** For male competitors of any age who are World Crossbow Shooting Association Members who cannot or do not want to enter the groups listed in 5.3.4, 5.3.6 or 5.3.8.
- 5.3.3 **WCSA JUNIOR GIRL:** WCSA Girl Members may compete in championships as a Junior Girl provided that they have NOT attained the age of 18 years on the first competition day.
- 5.3.4 **WCSA JUNIOR BOY:** WCSA Boy Members may compete in championships as a Junior Boy provided that they have NOT attained the age of 18 years on the first competition day.
- 5.3.5 **WCSA SENIOR WOMEN:** WCSA Women Members may compete as a Senior Woman provided they have attained the age of 55 years on or before the first day of the competition.
- 5.3.6 **WCSA SENIOR MEN:** WCSA Men Members may compete as a Senior Man provided they have attained the age of 55 years on or before the first day of the competition.
- 5.3.7 **WCSA ASSISTED WOMEN:** For those WCSA Female members with a physical disability. (There is no segregation of age groups in this Division)
- 5.3.8 **WCSA ASSISTED MEN:** For those WCSA Male Members with a physical disability. (There is no segregation of age groups in this Division)
- 5.3.9 **WCSA GUEST WOMEN:** This is for ALL female competitors who are NOT Members of the World Crossbow Shooting Association.
- 5.3.10 **WCSA GUEST MEN:** This is for ALL male competitors who are NOT Members of the World Crossbow Shooting Association.

### 5.4 Guest Competitors:

- 5.4.1 The World Crossbow Shooting Association shall decide if and who any Guest Competitors may be. Such competitors can be individuals or complete teams and are eligible to enter the Guest Division and receive awards. All guest competitors shall be assessed for competency, safety and knowledge of these rules to the satisfaction of the Technical Committee and/or Tournament Judges Commission.
- 5.4.2 Acceptance of a guest competitor shall not disadvantage Member Federations or Individual Members, particularly with regard to target availability.

## 6 ELIGIBILITY CODE

- 6.1 Competitors will respect the spirit of fair play and non-violence, and behave accordingly on the sports field.
- 6.2 Competitors will refrain from using substances and procedures prohibited by the laws of World Crossbow Shooting Association and the World Anti Doping Agency and will respect and comply in all aspects with the World Crossbow Shooting Association and the International Olympic Committee Medical Code.
- 6.3 A competitor may allow his or her person, name, picture or sport performances to be used for advertising purposes and may accept prizes and/or money without any restriction or limit.
- 6.4 Competitors will comply with the requirements of any World Crossbow Shooting Association sponsorship contracts during World Crossbow Shooting Association Championships.
- 6.5 Competitors may wear advertising in addition to the normal manufacturer's trade marks of the articles worn. The Manufacturers Trademark is the registered mark of the company which produced the item. If a company has an item made for it under contract, the label of the item, if appropriate to the item, will correspond to its trademark.
- 6.6 Competitors may have advertising on their personal and technical equipment (eg bows, bags, etc.) in addition to the item's normal trademark.

## 7 PROGRAM, OFFICIAL FUNCTIONS AND CEREMONIES

### 7.1 Program:

- 7.1.1 The program of the World Championships will be established by the Organising Committee with the approval of the World Crossbow Shooting Association Executive and will be published in the invitation to the Championships.
- 7.1.2 It will include:
- a) Team Managers Meeting
  - b) Equipment Inspection
  - c) Official Practice
  - d) Opening Ceremony

- e) Competition
- f) Awards Presentation
- g) Closing Ceremony
- h) Farewell Function

## 7.2 Reception:

7.2.1 Where possible at World Championships a reception for the official representatives of the participating Member Federations and representatives of the World Crossbow Shooting Association should take place.

## 7.3 Opening Ceremony:

7.3.1 At the beginning of the World Championships there will be an Opening Ceremony during which the necessary flags will be raised. Competitors and Team Officials should parade as teams on the field during the ceremony. The Organising Committee may provide cultural or other entertainment as it considers appropriate.

## 7.4 Awards Ceremony:

7.4.1 The President of the World Crossbow Shooting Association or his appointed representative (which may include sponsors representatives) shall present the place winners with their awards on the field immediately after completion of the competition and the scores have been confirmed.

## 7.5 Distribution of Special Prizes/awards:

7.5.1 These shall be distributed after the presentation of the main awards.

## 7.6 Closing Ceremony:

7.6.1 At the completion of the World Championships and after any Awards presentation has been completed, there will be a closing ceremony at which the World Crossbow Shooting Association Flag will be presented to the representative of the next World Crossbow Shooting Association World Championships.

## 7.7 Farewell Function:

7.7.1 There will be a social function at the completion of the World Championships to which all competitors and visitors will be invited.

## 8 DRESS REGULATIONS:

8.1 World Championships are special occasions very often attended by Dignitaries from various Governments and Organisations. It is therefore respectful that all competitors and officials participating in the opening and closing ceremonies should be properly dressed in **Medieval dress**, National Federation Uniform or dressed in all white.

8.2 During competitions

- a) **Medieval dress is permitted.**
- b) Women are required to wear dresses, skirts, split skirts, shorts or trousers and shirts, blouses or tops (which will cover the front and back of the body and be fixed over each shoulder).
- c) Men are required to wear full length trousers or shorts and long or short sleeved shirts.
- d) Dresses, skirts, split skirts and shorts may not be shorter than the competitor's fingertips when the arms and fingers are extended at the competitor's side.
- e) Sweaters/ cardigans may be worn.
- f) Track suits supplied to the team as official uniform will be permitted.
- g) All members of one team, men or women must be dressed in the same Team uniform.
- h) For safety reasons, Camouflage Clothing is **NOT** permitted to be worn when shooting the Forest or 3D rounds.

8.3 Enclosed Footwear must be worn by all competitors at all times during the tournament.

8.4 Competitor's registration number is to be prominently displayed and to be visible at all times while shooting is in progress.

8.5 Competitors are permitted to wear clothing, etc., on which appears the name and/or the official insignia, flag or emblem of the country they represent, without restriction as to size.

8.6 No advertising or slogans/sayings/drawings of any kind whatsoever will appear on clothing worn by the competitors or officials at any time during the tournament except as specified in the eligibility rules.

8.7 During inclement weather appropriate loose protective clothing may be worn (e.g. wet weather clothing).

**8.8 At any exhibitions or demonstrations Medieval/period costume should be worn.**

## 9 ACCREDITATION

9.1 The Organising Committee will issue to each participant and official appropriate accreditation, in accordance with World Crossbow Shooting Association Accreditation Guidelines.

9.2 The proof of accreditation will be carried at all times on the competition area and must be shown on the request of appropriate officials.

9.3 Only holders of appropriate accreditation will be allowed on to the relevant parts of the competition area.

## 10 CHAMPIONSHIP DOCUMENTS

10.1 The Organisers are responsible for producing the following documents:

- a) A program for the Championship indicating dates, times and location of all competitions, ceremonies, occasions and services of interest to competitors and officials; this program must have been approved by the Executive;
- b) Two lists of competitors, one with the indication of team officials and their championship address, and the other with division, target allocation and competition numbers;
- c) An interim results list, to be distributed after each distance, each match or each phase of the competition;
- d) A final, detailed results list of the scores of all competitors and/or teams with the indication of all title winners to be distributed to all Competitors, Team Managers, the WCSA President and Secretary General (for the WCSA web site) within a month of the closing day of the Championship.

## 11 TEAM AND INDIVIDUAL COMPETITIONS

- 11.1 At World Championships, Team and Individual competitions will be conducted in accordance with these Competition Rules.
- 11.2 **Team Competitions:**
- 11.2.1 Each Member Federation has the right to enter teams which will be made up only of Nationals from that Country in each of the WCSA Women, WCSA Men, WCSA Junior Girls, WCSA Junior Boys, WCSA Senior Women, WCSA Senior Men, WCSA Assisted Women and WCSA Assisted Men as specified in 11.2.2.
- Each non World Crossbow Shooting Association Entry may enter Teams which will be made up of only Nationals from that Country's Entry in the Guest Men Championships and the Guest Women Championships as specified in 11.2.2.
- 11.2.2 The constitution of teams shall be:
- |                      |  |
|----------------------|--|
| WCSA WOMEN:          | Three (3) competitors (Must be Women but can include Juniors, Seniors and Assisted);   |
| WCSA MEN:            | Three (3) competitors (Should be all Men where possible but Women are permitted and can include Juniors, Seniors and Assisted);          |
| WCSA JUNIOR GIRLS:   | Three (3) competitors (Must be Junior Girls or Assisted Girls of Juniors Division age);  |
| WCSA JUNIOR BOYS:    | Three (3) competitors (Should be all Boys where possible but Girls are permitted and can include Assisted but all must be of Junior age) |
| WCSA SENIOR WOMEN:   | Three (3) competitors (Must be Senior Women or Assisted Women of Seniors Division age)   |
| WCSA SENIOR MEN:     | Three (3) competitors (Should be all Men where possible but Women are permitted and can include Assisted but all must be of Senior age)  |
| WCSA ASSISTED WOMEN: | Two (2) competitors (Must be Assisted Women)   |
| WCSA ASSISTED MEN:   | Two (2) competitors (Should be all Men but one (1) of either gender is permitted but they must be Assisted Competitors)                  |
| GUEST WOMEN:         | Three (3) competitors (Females only) (Non WCSA Members can only enter this event)  |
| GUEST MEN:           | Three (3) competitors (Should be all Male but females are permitted) (Non WCSA Members can only enter this event)                        |
- 11.3 **Substitute Competitors:**
- 11.3.1 Member Federations, Non World Crossbow Shooting Association Members or other Guest entrants may select members as team reserves. They must be listed by name and substituted in order of their listing. Such substitutes may only be made with the consent of the Organising Committee. No substitutions will be permitted after the start of the competition.
- 11.4 **Individual Competitors:**
- 11.4.1 These may be individuals from World Crossbow Shooting Association Member Federations, Clubs or World Crossbow Shooting Association Individual Members, non World Crossbow Shooting Association Members or other individual Guest entrants. There may be as many Individual Competitors, irrespective of whether they are part of their Federation's Team, as can be accommodated by the Organising Committee.
- 11.4.2 There must be a minimum of 5 competitors in a Division for the World Championship of that Division to take place. For example there must be 5 Senior Women for there to be a competition for the position of WCSA World Champion Senior Woman Outdoor Target. If there is not 5 competitors for a Division those that entered have the option of shooting in the Open Women or Men Division or as a participant with no World Championship Title or medal (an award may be presented), unless special dispensation is granted by the Executive.
- 11.5 A World Crossbow Shooting Association Member Federation, non World Crossbow Shooting Association Members or any other Guest Entrant Association which does not have enough competitors to enter a full team may enter their Members as individual competitors.
- 11.6 The reigning individual World Champions have the right to participate in the next World Championships as individual competitors.

## 12 TARGET ASSIGNMENT

### 12.1 OUTDOOR AND INDOOR TARGET

- 12.1.1 **Target Numbers:** At World Crossbow Shooting Association World Championships the assignment of Target Numbers shall be the responsibility of the Organising Committee. One competitor shall be assigned to each target face.
- 12.1.2 The reigning World Champions in Target and Match-play, Man, Woman, Junior, Senior, Assisted and Guest who are present and competing shall start with target assignments 1-2-3-4 and upwards respectively, before other competitors are assigned. The assignments shall be in the order of:
- Target 1 World Crossbow Shooting Association Men's Target Champion,
  - Target 2 World Crossbow Shooting Association Women's Target Champion,
  - Target 3 World Crossbow Shooting Association Men's Match-play Champion,
  - Target 4 World Crossbow Shooting Association Women's Match-play Champion,
  - Target 5 World Crossbow Shooting Association Senior Men's Target Champion,
  - Target 6 World Crossbow Shooting Association Senior Women's Target Champion,
  - Target 7 World Crossbow Shooting Association Senior Men's Match-play Champion,
  - Target 8 World Crossbow Shooting Association Senior Women's Match-play Champion,
  - Target 9 World Crossbow Shooting Association Junior Boy's Target Champion,
  - Target 10 World Crossbow Shooting Association Junior Girl's Target Champion,
  - Target 11 World Crossbow Shooting Association Junior Boy's Match-play Champion,
  - Target 12 World Crossbow Shooting Association Junior Girl's Match-play Champion,

Target 13 World Crossbow Shooting Association Assisted Men's Target Champion,  
Target 14 World Crossbow Shooting Association Assisted Women's Target Champion,  
Target 15 World Crossbow Shooting Association Assisted Men's Match-play Champion,  
Target 16 World Crossbow Shooting Association Assisted Women's Match-play Champion,  
Target 17 World Crossbow Shooting Association Guest Men's Target Champion,  
Target 18 World Crossbow Shooting Association Guest Women's Target Champion,  
Target 19 World Crossbow Shooting Association Guest Men's Match-play Champion,  
Target 20 World Crossbow Shooting Association Guest Women's Match-play Champion

12.1.3 The Organising Committee will conduct a draw for Target Numbers prior to the first Official Practice session, witnessed by the Chairman of the Judges Commission, Team Managers and a Representative of the Technical Committee and Executive, as follows:

12.1.3.1 There shall be as many cards as there are competitors taking part each card bearing the name of one competitor. They will be placed in and drawn from a container. All competitors shall be drawn irrespective of sex, age or physical ability. Non World Crossbow Shooting Association Members entering the Guest Championships will be incorporated and drawn at the same time.

12.1.3.2 The Chairman or Secretary of the Organising Committee will draw the competitors' names which will be allocated numerically in ascending order to each target in turn following on from the present World Champions target allocations until all competitors have been allocated a target.

12.1.3.3 The Organising Committee will notify in writing to members of the World Crossbow Shooting Association Executive who are present, the Judges Commission, the Director of Shooting, Team Managers and Individual Competitors the target allocations immediately after the draw has been completed. A list of target allocations shall be placed on display by the Organising Committee, for the spectators and members of the Press.

12.1.4 **Second Day Target Assignment**

12.1.4.1 Target assignments for the second day of Outdoor and Indoor Target Competition shall be allocated according to the individual competitor's score after the first SC600 or SC600 Round has been completed (including Non World Crossbow Shooting Association Members and Guest Competitors). The highest scoring competitor shall be assigned to target 1, the second highest scoring competitor to target 2 and continued in that order until all competitors have been assigned a target.

## 12.2 FOREST AND 3D ROUNDS

12.2.1 **Target Groups:** At World Crossbow Shooting Association World Championships the assignment of Target Groups shall be the responsibility of the Organising Committee. No less than two (2) or more than four (4) competitors shall be assigned to each group. There shall preferably be no more than 2 competitors from the same Federation in the same target group.

12.2.2 The Target Group assignments shall be done by the Organising Committee to allow for the best running of the event. It may be beneficial to have any Assisted Competitors in the same group as their Championship Round target numbers may have to be modified slightly to accommodate their chair and movement situation. (this allows flexibility to the Organising Committee)

12.2.3 The Groups will be numbered from 1 upwards and the competitors will be allocated a letter either A, B, C or D so that the number 1 group will be allocated 1A, 1B, 1C and 1D, number 2 group 2A, 2B, 2C, 2D and continued on.

12.2.4 The groups can be allocated any numbered Target to start on. For example group 1 could be allocated to start at target number 13.

12.2.5 The Organising Committee will notify in writing to members of the World Crossbow Shooting Association Executive who are present, the Judges Commission, the Director of Shooting, Team Managers and Individual Competitors the group allocations immediately after the allocation has been completed. A list of Group allocations shall be placed on display by the Organising Committee, for the spectators and members of the Press.

12.2.6 The groups as allocated will remain together for the whole of the event.

## 13 COMPETITOR NUMBERS

13.1 The Organising Committee shall issue all competitors with Competitor Numbers, such that they may be visible from a distance of at least 50 metres. Minimum size of the sheet shall be 250mm x 150 mm with numbers at least 100 mm high. Such competitor numbers may carry sponsor logos.

13.2 Competitors shall wear their Competitor Number on the middle of the back, in such a manner as to be visible at all times while shooting is in progress, including while wearing weatherproof clothing.

## 14 OFFICIAL COMMUNICATION

14.1 The Organising Committee shall provide suitable labelled pigeon holes or trays, one each for:- the World Crossbow Shooting Association Executive who are present, the Judges Commission and each of the Team Managers. A Notice Board for the information of Individual Competitors will be provided and kept up to date. These shall be located within easy access of the shooting ground.

## 15 EQUAL SHOOTING CONDITIONS

15.1 Shooting conditions in terms of the condition of the ground surface, visual distraction, noise, climatic conditions, light, etc, shall be uniform for all competitors, as far as is reasonably possible.

## 16 MEDALS, TROPHIES AND PERFORMANCE AWARDS

16.1 **Medals**

16.1.1 World Crossbow Shooting Association Championship medals shall be awarded to the first, second and third place in each division and event of the Championships.

- 16.1.2 In the Outdoor Target Team Event all members of that team shall receive medals.
- 16.1.3 The medal must have on the front the emblem of the World Crossbow Shooting Association. On the back must be the name of the event and the category. Also on either the front or back there must be the number and year of the Championships the city and country where it was held. See sample artwork below at 16.1.9.
- 16.1.4 The medals for World Championships shall be Round in shape, no smaller than 40 mm in diameter.
- 16.1.5 The medal shall be suspended by a ribbon a minimum of 20mm wide one meter long sewn in the form of a loop so that it can be hung around the neck of the winner.
- 16.1.6 The medals shall be gold for first place, silver for second place and bronze for third place.
- 16.1.7 All medals and ribbons shall be supplied by the Executive at least two months before the date of the Championship.
- 16.1.8 The total cost of all Championship Medals shall be borne by the Organising Committee.
- 16.1.9 **Sample of Medal Artwork**

Front



Back



## 16.2 Prizes and Trophies

- 16.2.1 The Executive may receive for World Crossbow Shooting Association the donation of Challenge Trophies for World Crossbow Shooting Association World Championships. Such Challenge Trophies shall remain the property of the World Crossbow Shooting Association.
- 16.2.2 The Organising Committee may arrange special prizes, trophies or awards as required.

## 17 TEAM OFFICIALS

- 17.1 Each participating Member Federation Team should be represented by a Team Manager. A Member Federation Team Manager may be a competitor or non-competitor. Member Federation Team Managers shall generally represent their team in all matters pertaining to the championships.
- 17.2 The Member Federation Team Managers shall:
- contact the Organising Committee as soon as possible after arrival,
  - attend Team Managers' Meetings as necessary, and,
  - accompany their teams during equipment checking.
- 17.3 The Member Federation Team Managers shall represent their teams in the event of disputes either to the Organising Committee or the International Judges' Committee.
- 17.4 Each Member Federation Team may also be represented by an Assistant Team Manager (Coach).
- 17.5 One person may act simultaneously as National Team Manager for not more than two (2) Member Federations.
- 17.6 Items 17.1 to 17.5 also apply to Guest and Non World Crossbow Shooting Association entrants.

## 18 INDIVIDUAL COMPETITORS

- 18.1 It is the responsibility of Individual Competitors without a Team Manager to report to the Organising Committee on arrival and to keep themselves informed and up to date with relevant information by regularly checking the information notice board.

## 19 TECHNICAL DELEGATE

- 19.1 A Technical Delegate will be appointed by the World Crossbow Shooting Association to oversee the technical aspects of Championships.
- 19.2 The Technical Delegate's tasks will be to:
- Advise the organisers on the World Crossbow Shooting Association Rules and the implementation of these rules;
  - Inspect the sports facilities and the venue equipment to be used during the competition;
  - Check that all preparations are in accordance with World Crossbow Shooting Association requirements and the respective Organiser's manual.
  - Report to the World Crossbow Shooting Association Executive on a regular basis on the progress of the preparation of the championship;
  - Supervise and attend the target allocation draw,
  - Organise and chair the Team Captain's meeting and make sure that individual competitors are given adequate up to date information,
  - Co-operate closely with the Chairperson of the Judge Commission and the Director of Shooting,
  - Ensure that the shooting rules of World Crossbow Shooting Association will be observed and advise the Organising Committee on necessary changes to protect the best interests of World Crossbow Shooting Association and the quality of the Championship.
- 19.3 The Technical Delegate will normally be a member of the World Crossbow Shooting Association Technical Committee.

## 20 JURY OF APPEAL

- 20.1 A Jury of Appeal of three members shall be appointed by the World Crossbow Shooting Association Executive for every World Crossbow Shooting Association Championship. Persons participating in the Championships are not eligible for the Jury of Appeal. Members of the Jury of Appeal shall preferably be World Crossbow Shooting Association Officers. Where a Jury of Appeal has not been appointed, the Organising Committee shall assume this role.
- 20.2 Appeals against rulings by the Judges must be presented, in writing, by Team Managers, or appellants if no Team Manager has been designated or they are individual member competitors. No appeal can be made against the value of a bolt. An intention to appeal when it might affect the progression of a competitor from one stage of the competition to the next, must be expressed in writing and lodged with the Chairperson of the Tournament Judge Commission within 5 minutes of the end of the match or within 30 minutes of the completion of the days shooting. The written appeal must be lodged with the Jury in time to allow the Jury to come to a decision before the beginning of the next stage of the competition.
- 20.3 The Jury must be available at the Tournament grounds at all times during the Tournament or event (including the day of official practice) until thirty minutes after the end of shooting.
- 20.4 Jury decisions shall be minuted and submitted to the appellant, the Chairperson of the Tournament Judge Commission and the Organising Committee before the beginning of the next stage of the competition or before the awarding of prizes. The ruling of the Jury of Appeal shall be final.
- 20.5 Protest Fee**
- 20.5.1 All appeals must be submitted in writing not later than one hour after the close of the days shooting and before any prize giving and be accompanied by a fee of US\$25 or its equivalent. The fee shall be returned if the appeal is upheld and shall be retained by the Organising Committee if the appeal is lost. (50% to the Organising Committee and 50% to World Crossbow Shooting Association funds).
- 20.6 Decisions made by the Jury of Appeal must be documented and submitted to the appellant, the Chairman of the Judges Commission and the Chairperson of the Organising Committee before the awarding, of prizes or the next stage of the competition as the case may be. This terminates the path of appeal.

## 21 DISCIPLINARY ACTION

- 21.1 Competitors and Officials shall conform with the World Crossbow Shooting Association Constitution and Rules as well as any decisions and directives made by the International Judge's Commission.
- 21.2 A competitor shown to have unknowingly violated any Rule or Regulation shall be given a verbal warning by a judge and informed that any further violation could be cause for disqualification. A warning shall be expressed by showing a YELLOW CARD with the word 'WARNING' printed thereon, to the competitor concerned and to their Team Manager (if they have one). If the competitor is shooting on the course in a Forest or 3D Tournament, they will be warned as above and the information will be radioed into central control by a Judge .
- 21.3 A competitor who has violated any Rule or Regulation and having previously been shown the Yellow (Warning Card), shall be ruled, by the Judge, not to be eligible to participate and shall be disqualified from the competition. Disqualification shall be expressed by showing a RED CARD with the word 'DISQUALIFICATION' printed on.
- Note: The size of the cards should be approximately 70 x100 mm.
- 21.4 A competitor may appeal against such a decision to the Jury of Appeal, immediately and in writing. The appeal shall be handed to a Member of the Judge's Commission for delivery. The decision of the Jury of Appeal is final. A competitor on a Forest or 3D course may continue shooting and scoring until the outcome of the decision is known.

## 22 DOPING CONTROL

- 22.1 At World Crossbow Shooting Association sanctioned events, Doping Control will be at the request of the World Crossbow Shooting Association Executive or the host Organising Committee. Doping test will be in conformity with the World Crossbow Shooting Association Anti-Doping Policy. The host Organising Committee is responsible for meeting the costs of drug testing. The number of tests to be conducted must be in accordance with these rules.
- 22.2 **Doping is:**
- the use of an expedient (substance or method) which is potentially harmful to the competitor's health and/or capable of enhancing their performance
  - the presence in a competitor's body of a prohibited substance or evidence of the use thereof or evidence of the use of a prohibited substance.
- Alcohol is a banned substance.**
- 22.3 Doping is forbidden in all World Crossbow Shooting Association sanctioned events.
- 22.4 Medical Provisions**
- 22.4.1 All competitors competing, in events sanctioned by the World Crossbow Shooting Association must agree to submit to such medical tests or examinations as may be required by the World Crossbow Shooting Association, the organisers of the event or by the laws of the country in which the event takes place.
- 22.5 Competitor's Declaration**
- 22.5.1 Each Competitor will be required to sign a Declaration confirming their awareness of the World Crossbow Shooting Association's prevailing Anti-Doping Control regulations and penalties.
- 22.5.2 The wording of such Declaration shall be determined by the World Crossbow Shooting Association Executive.
- 22.5.3 Competitor's declaration forms shall be completed before or during equipment inspection.
- 22.6 Officials' Declaration**
- 22.6.1 The Member Federation Team Manager responsible for their Member Federation's Competitors shall be required to countersign all appropriate Competitors' Declarations.
- 22.7 Medical Tests:**
- 22.7.1 All athletes are subject to doping control (urine analysis, blood tests and other authorised techniques for detecting prohibited substances or methods). All athletes must submit to the doping control if he/she has been selected.
- 22.7.2 Any athlete refusing to submit to the doping control will be considered as if the result of this control has been

positive.

22.7.3 Any person who aids in doping will be sanctioned.

22.7.4 Any such occurrences shall be reported to the World Crossbow Shooting Association by the organisers of the event.

## 22.8 Drug Test Results:

22.8.1 The host Organising Committee shall submit any copies of the official Drug Test Results to the World Crossbow Shooting Association within one (1) month of the competition.

## 23 DIRECTOR OF SHOOTING

23.1 The World Crossbow Shooting Association Judges Committee will appoint a Director of Shooting for Outdoor and Indoor Target events who must be an International Judge and who is to be notified to the World Crossbow Shooting Association Executive and the Organising Committee for approval at least 90 days before the first day of competition.

23.2 The Organising Committee will appoint a Deputy Director of Shooting and, if necessary, one or more Assistants. Their names will be informed to the World Crossbow Shooting Association Secretary General at least 90 days before the first day of competition.

23.3 The Director of Shooting, his Deputy and his Assistants will not have other tasks during the hours of competition nor take part in the shooting.

23.4 For the Forest and 3D rounds the Chair of the Tournament Judges Commission will be in control.

## 24 TOURNAMENT JUDGE COMMISSION

24.1 Judging activities at World Crossbow Shooting Association Championships will be co-ordinated by the Tournament Judges Commission.

24.2 The number of Judges will be not less than one for every 30 competitors in the Outdoor and Indoor Target Championships and not less than one for every 8 Targets in Forest and 3D Championships. There must be a minimum of 3 Judges at any World Championship Event.

24.3 Judges are expected to be in possession of the equipment specified by the World Crossbow Shooting Association Judges Committee.

24.4 Judges will be appointed by the World Crossbow Shooting Association Judge Committee.

24.5 The World Crossbow Shooting Association Judges Committee will communicate the names of these Judges to the World Crossbow Shooting Association Secretary General and the Organising Committee for acceptance and approval no later than ninety (90) days before the first day of the competition. The World Crossbow Shooting Association Judges Committee must receive confirmation of the Judges' availability before making the appointment.

24.6 If possible, no more than two Judges will be drawn from any one Member Federation

24.7 The World Crossbow Shooting Association Judges Committee will appoint one Judge as Chairperson.

24.8 These Judges will be referred to as the Tournament Judge Commission.

24.9 The Tournament Judges Commission will co-operate closely with the Technical Delegate.

24.10 The Tournament Judges Commission, through their chairperson will present to the World Crossbow Shooting Association Secretary General and the World Crossbow Shooting Association Judges Committee Chairman a report regarding the conduct of the Tournament.

## 25 EQUIPMENT SCRUTINEERING AND CONTROL

25.1 At World Championships and events sanctioned by the World Crossbow Shooting Association the crossbows, shooting equipment, accessories and clothing of all competitors shall be checked, for compliance with these competition rules, by the Tournament Judges Commission at an official equipment scrutineering session (which is to be held prior to or during official practice).

25.2 Control Stickers: Crossbows having been approved as correct shall be marked with a suitable sticker bearing the name and date of the competition. The approval and relevant information must also be recorded on a control sheet, provided by the Organising Committee, in accordance with the format specified.

25.3 Spare Equipment: Spare equipment (crossbows, prods bolts etc) to be used in the case of equipment failure must also be submitted for approval during equipment scrutineering at the time appointed by the organisers.

25.4 After equipment has been approved, it must not be altered at any time prior to or during the competition in any way that would conflict with these Rules. If there are any doubts regarding an alteration, the equipment must be returned to Equipment Control for re-inspection and approval.

25.5 A competitor found to be using unapproved or altered equipment or having, removed Official Control Stickers will face IMMEDIATE DISQUALIFICATION.

25.6 Further inspection of equipment such as in the case of equipment failure shall take place as appropriate.

25.7 Crossbows, bolts and clothing of the leading competitors in each division may be re-checked for compliance with these Competition Rules by the Tournament Judges Commission BEFORE such equipment is removed from the Equipment Line in Target and on leaving the course in Forest and 3D at the completion of each competition round .

25.8 The Tournament Judges Commission may elect to inspect all competitors' equipment at the completion of a competition round, at its discretion, provided that this is appropriately announced.

25.9 Approval of the equipment is valid only for the competition for which the inspection was made.

## 26 SCORING

### 26.1 OUTDOOR AND INDOOR TARGET

26.1.1 There will be independent scorers in sufficient numbers in a World Target Championship to ensure each 10 competitors in the Target Rounds has a scorer.

26.1.2 These scorers can be competitors when the Organising Committee have problems in obtaining scorers and providing it has been approved by the World Crossbow Shooting Association Executive. Scorers assigned by the

Organisers and who do not take part in the shooting must not become involved in any discussion regarding the value of a bolt.

- 26.1.3 The scorers who are not competitors will work under the supervision of one or more officials appointed by the Organisers, who will be responsible for the correct conduct of the scoring.
- 26.1.4 Where possible one or more scoreboards, of sufficient size to show the target number, name, code for Member Federation and progressive score of at least the first eight in each event shall be maintained.
- 26.1.5 In Target Championships results lists for all competitors must be published and made available on the field after each distance and/or round. The Organisers are encouraged to display results lists more frequently if possible.
- 26.1.6 In the case of electronic scoring, manual score cards must also be kept. The bolt values entered on the manual score cards are the official values.
- 26.1.7 There shall be double scoring at World Championships if the scoring is done by the competitors.

## 26.2 FOREST AND 3D

- 26.2.1 There will be 2 Competitors assigned as scorers in each target group at a World Championship.
- 26.2.2 The Organising Committee may appoint independent scorers if they can obtain sufficient scorers for one per group and providing it has been approved by the World Crossbow Shooting Association Executive. Scorers assigned by the Organisers and who do not take part in the shooting must not become involved in any discussion regarding the value of a bolt nor the carrying of any competitors equipment.
- 26.2.3 The scorers who are not competitors will work under the supervision of one or more officials appointed by the Organisers, who will be responsible for the correct conduct of the scoring.
- 26.2.4 In Forest and 3D Championships results lists for all competitors must be published and made available on the field after each round. The Organisers are encouraged to display results lists more frequently if possible.
- 26.2.5 In the case of electronic scoring, manual score cards must also be kept. The bolt values entered on the manual score cards are the official values.
- 26.2.6 There shall be double scoring at World Championships if the scoring is done by competitors.

## 27 PRACTICE

- 27.1 Practice will at all times be under the control of a Director of Shooting.
- 27.2 The Director of Shooting shall be solely responsible for the conduct of shooting,
- 27.3 It is suggested that a fixed period of time (eg. 5 minutes) be allocated for shooting, and that there shall be no limit to the number of bolts which can be shot within this time limit.
- 27.4 Control of Practice: All competitors shall move forward together to collect their bolts, irrespective of the distance being shot. No competitor shall shoot during this time, nor collect bolts at any other time.
- 27.5 The Director of Shooting may bar from the practice session any competitor contravening this rule.
- 27.6 Allocation of Butts for Unofficial Practice:  
On Unofficial Practice days:-  
Outdoor Target - the butts shall be set out at distances of 40, 30 and 20m,  
Indoor Target – the butts shall be set out at the distance of 18m  
Forest and 3D – the butts shall be set out with the required face and target size at distances within the range required.  
The quantity of butts shall be in a proportional number according to the number of competitors and as requested by the Director of Shooting.
- 27.7 Competitors desirous of changing the butt allocation shall negotiate with the Director of Shooting. Any change in the distance at which targets are set shall be regulated by the Director of Shooting, who may ask practicing competitors to assist in moving, and re-arranging targets.
- 27.8 **Conduct of Official Practice for Target:**  
Official Practice shall take place on the tournament field in accordance with the details set out in the Program, in that the regulation of ends (visual time control) under the control of the Director of Shooting shall be employed. Members of the Judges Commission shall be present to observe the conduct of the shooting and advise competitors over matters of procedure (through Team Managers if present).
- 27.9 Official Practice Butt Allocation for Target: each competitor shall use the target assigned to him/her for the first day of competition.
- 27.10 Official Practice Day Range Layout: all butts shall be set at 20 metres to begin Official Practice, then moved to 30 metres, and then finish the session at 40 metres for all competitors.
- 27.11 Official Practice Timetable: The timetable shall be submitted to the Judges Commission for approval no later than twenty four (24) hours before the start of Official Practice.
- 27.12 Recommended timings:  
0900 - 1100 hours 20 metre practice  
1100 - 1200 hours Lunch  
1200 - 1400 hours 30 metre practice  
1430 - 1630 hours 40 metre practice
- 27.13 Practice (shooting) on the tournament field or the practice field between the official start and finish times on the days of competition is **NOT PERMITTED**.
- 27.14 The Organising Committee shall preferably make practice butts available for practice purposes on an adjacent field, equivalent to at least 20% of the number of competitors.
- 27.15 On competition days, such facilities shall be available as announced in the Program and shall be closed 30 minutes prior to the published competition start time. These facilities may be re-opened for a specified period, 30 minutes after the close of shooting,



- 27.16 **Test Butt:** For the purpose of testing a crossbow which has undergone essential repairs (eg trigger) a target butt shall be set out at a maximum distance of 20 metres in an area separated from the main tournament field. The use of such test facilities shall be under the supervision of a Technical or Judge Commission Member.
- 27.17 **Practice of the Shooting Stance:** On days of Target competition before the competition starts and during the intervals between distances, competitors may practice only the shooting position and sighting, without cocking/spanning/loading their crossbows. Such practice may only take place on the shooting line and in the direction of the competitor's allocated target, providing the aiming area is clear of persons and it is safe to do so. In the event that a bolt is shot during such practice, the competitor will be banned from any further shooting in the competition.

## 28 WORLD CHAMPIONSHIP TITLES

- 28.1 There must be a minimum of 5 competitors in an Individual Division for the World Championship of that Division to take place. For example there must be 5 Senior Women for there to be a competition for the position of WCSA Outdoor Target Senior Woman Champion of the World. If there is not 5 competitors for a Division those that entered have the option of shooting in the Open Division or as a participant with no World Championship Title or medal (an award may be presented) unless a special dispensation has been granted by the Executive.

### 28.2 Outdoor Target World Championships Medieval Crossbow Division:

**Individual:**

World Crossbow Shooting Association Outdoor Target Woman Champion of the World;  
 World Crossbow Shooting Association Outdoor Target Man Champion of the World;  
 World Crossbow Shooting Association Outdoor Target Junior Girl Champion of the World;  
 World Crossbow Shooting Association Outdoor Target Junior Boy Champion of the World;  
 World Crossbow Shooting Association Outdoor Target Senior Woman Champion of the World;  
 World Crossbow Shooting Association Outdoor Target Senior Man Champion of the World;  
 World Crossbow Shooting Association Outdoor Target Assisted Woman Champion of the World.  
 World Crossbow Shooting Association Outdoor Target Assisted Man Champion of the World.  
 World Crossbow Shooting Association Outdoor Target Guest Man Champion of the World  
 World Crossbow Shooting Association Outdoor Target Guest Woman Champion of the World

**Team:**

World Crossbow Shooting Association Outdoor Target Women's Champion Team of the World;  
 World Crossbow Shooting Association Outdoor Target Men's Champion Team of the World;  
 World Crossbow Shooting Association Outdoor Target Junior Girl's Champion Team of the World;  
 World Crossbow Shooting Association Outdoor Target Junior Boy's Champion Team of the World;  
 World Crossbow Shooting Association Outdoor Target Senior Woman's Champion Team of the World;  
 World Crossbow Shooting Association Outdoor Target Senior Man's Champion Team of the World;  
 World Crossbow Shooting Association Outdoor Target Assisted Women's Champion Team of the World.  
 World Crossbow Shooting Association Outdoor Target Assisted Men's Champion Team of the World.  
 World Crossbow Shooting Association Outdoor Target Guest Men's Champion Team of the World  
 World Crossbow Shooting Association Outdoor Target Guest Women's Champion Team of the World

### 28.3 Outdoor Match-play World Championships Medieval Crossbow Division:

**Individual:**

World Crossbow Shooting Association Outdoor Match-play Woman Champion of the World;  
 World Crossbow Shooting Association Outdoor Match-play Man Champion of the World;  
 World Crossbow Shooting Association Outdoor Match-play Junior Girl Champion of the World;  
 World Crossbow Shooting Association Outdoor Match-play Junior Man Champion of the World;  
 World Crossbow Shooting Association Outdoor Match-play Senior Woman Champion of the World;  
 World Crossbow Shooting Association Outdoor Match-play Senior Man Champion of the World;  
 World Crossbow Shooting Association Outdoor Match-play Assisted Woman Champion of the World.  
 World Crossbow Shooting Association Outdoor Match-play Assisted Man Champion of the World.  
 World Crossbow Shooting Association Outdoor Match-play Guest Man Champion of the World  
 World Crossbow Shooting Association Outdoor Match-play Guest Woman Champion of the World

### 28.4 Indoor Target World Championships Medieval Crossbow Division:

**Individual:**

World Crossbow Shooting Association Indoor Target Woman Champion of the World;  
 World Crossbow Shooting Association Indoor Target Man Champion of the World;  
 World Crossbow Shooting Association Indoor Target Junior Girl Champion of the World;  
 World Crossbow Shooting Association Indoor Target Junior Boy Champion of the World;  
 World Crossbow Shooting Association Indoor Target Senior Woman Champion of the World;  
 World Crossbow Shooting Association Indoor Target Senior Man Champion of the World;  
 World Crossbow Shooting Association Indoor Target Assisted Woman Champion of the World.  
 World Crossbow Shooting Association Indoor Target Assisted Man Champion of the World.  
 World Crossbow Shooting Association Indoor Target Guest Man Champion of the World  
 World Crossbow Shooting Association Indoor Target Guest Woman Champion of the World

**Team:**

World Crossbow Shooting Association Indoor Target Women's Champion Team of the World;  
 World Crossbow Shooting Association Indoor Target Men's Champion Team of the World;  
 World Crossbow Shooting Association Indoor Target Junior Girl's Champion Team of the World;  
 World Crossbow Shooting Association Indoor Target Junior Boy's Champion Team of the World;  
 World Crossbow Shooting Association Indoor Target Senior Woman's Champion Team of the World;  
 World Crossbow Shooting Association Indoor Target Senior Man's Champion Team of the World;  
 World Crossbow Shooting Association Indoor Target Assisted Woman's Champion Team of the World  
 World Crossbow Shooting Association Indoor Target Assisted Man's Champion Team of the World  
 World Crossbow Shooting Association Indoor Target Guest Men's Champion Team of the World  
 World Crossbow Shooting Association Indoor Target Guest Women's Champion Team of the World

28.5 **Indoor Match-play World Championships Medieval Crossbow Division:**

**Individual:**

World Crossbow Shooting Association Indoor Match-play Woman Champion of the World;  
 World Crossbow Shooting Association Indoor Match-play Man Champion of the World;  
 World Crossbow Shooting Association Indoor Match-play Junior Girl Champion of the World;  
 World Crossbow Shooting Association Indoor Match-play Junior Boy Champion of the World;  
 World Crossbow Shooting Association Indoor Match-play Senior Woman Champion of the World;  
 World Crossbow Shooting Association Indoor Match-play Senior Man Champion of the World;  
 World Crossbow Shooting Association Indoor Match-play Assisted Woman Champion of the World  
 World Crossbow Shooting Association Indoor Match-play Assisted Man Champion of the World.  
 World Crossbow Shooting Association Indoor Match-play Guest Man Champion of the World  
 World Crossbow Shooting Association Indoor Match-play Guest Woman Champion of the World

28.6 **Forest Round World Championships Medieval Crossbow Division:**

**Individual:**

World Crossbow Shooting Association Forest Round Woman Champion of the World  
 World Crossbow Shooting Association Forest Round Man Champion of the World;  
 World Crossbow Shooting Association Forest Round Junior Girl Champion of the World;  
 World Crossbow Shooting Association Forest Round Junior Boy Champion of the World;  
 World Crossbow Shooting Association Forest Round Senior Woman Champion of the World;  
 World Crossbow Shooting Association Forest Round Senior Man Champion of the World;  
 World Crossbow Shooting Association Forest Round Assisted Woman Champion of the World.  
 World Crossbow Shooting Association Forest Round Assisted Man Champion of the World.  
 World Crossbow Shooting Association Forest Round Guest Man Champion of the World  
 World Crossbow Shooting Association Forest Round Guest Woman Champion of the World

**Team:**

World Crossbow Shooting Association Forest Round Women's Champion Team of the World;  
 World Crossbow Shooting Association Forest Round Men's Champion Team of the World;  
 World Crossbow Shooting Association Forest Round Junior Girl's Champion Team of the World;  
 World Crossbow Shooting Association Forest Round Junior Boy's Champion Team of the World;  
 World Crossbow Shooting Association Forest Round Senior Women's Champion Team of the World;  
 World Crossbow Shooting Association Forest Round Senior Men's Champion Team of the World;  
 World Crossbow Shooting Association Forest Round Assisted Women's Champion Team of the World  
 World Crossbow Shooting Association Forest Round Assisted Men's Champion Team of the World  
 World Crossbow Shooting Association Forest Round Guest Men's Champion Team of the World  
 World Crossbow Shooting Association Forest Round Guest Women's Champion Team of the World

28.7 **3D Round World Championships Medieval Crossbow Division:**

**Individual:**

World Crossbow Shooting Association 3D Woman Champion of the World;  
 World Crossbow Shooting Association 3D Man Champion of the World;  
 World Crossbow Shooting Association 3D Junior Girl Champion of the World;  
 World Crossbow Shooting Association 3D Junior Boy Champion of the World;  
 World Crossbow Shooting Association 3D Senior Woman Champion of the World;  
 World Crossbow Shooting Association 3D Senior Man Champion of the World;  
 World Crossbow Shooting Association 3D Assisted Woman Champion of the World.  
 World Crossbow Shooting Association 3D Assisted Man Champion of the World.  
 World Crossbow Shooting Association 3D Guest Man Champion of the World  
 World Crossbow Shooting Association 3D Guest Woman Champion of the World

**Team:**

World Crossbow Shooting Association 3D Women's Champion Team of the World;  
 World Crossbow Shooting Association 3D Men's Champion Team of the World;  
 World Crossbow Shooting Association 3D Junior Girl's Champion Team of the World;

World Crossbow Shooting Association 3D Junior Boy's Champion Team of the World;  
 World Crossbow Shooting Association 3D Senior Women's Champion Team of the World;  
 World Crossbow Shooting Association 3D Senior Men's Champion Team of the World;  
 World Crossbow Shooting Association 3D Assisted Women's Champion Team of the World;  
 World Crossbow Shooting Association 3D Assisted Men's Champion Team of the World;  
 World Crossbow Shooting Association 3D Guest Men's Champion Team of the World;  
 World Crossbow Shooting Association 3D Guest Women's Champion Team of the World

## 29 WORLD CHAMPIONSHIP ROUNDS.

### 29.1 Outdoor Target

**Name of round: Medieval Crossbow 600 (MC600)**

**Distances: Day 1 shot in order 40m, 30m, 20m - Day 2 shot in order 20m, 30m, 40m**

**Ends:** 10 ends X **2 Bolts** per end = **20 bolts** each distance.

**Timing:** **90 seconds** per bolt = 3 minutes per **2 bolts**

**Face:** 60cm multi coloured - 10 zone scoring

**Practice:** 2 ends of **2 bolts** in 5 minutes at the start of day's shooting and 1 end of **2 bolts** in 5 minutes at the beginning of each distance.

### 29.2 Outdoor Match-Play

**Distance: 30m**

**Ends:** 3 ends X **2 bolts** per end per Match = total of 6 bolts per Match.

**Time:** 90 seconds per Bolt = 3 minutes per **2 bolts**

**Practice:** On nearby range on same ground so conditions are the same. NO practice shots on the competition range.

**Eliminations:** Start with 16 competitors (8 matches), all shoot together and score - cut to 8 (4 matches), all shoot together and score

**Finals:**

**Semi:** 4 competitors (2 matches), competitors in each match shoot A & B detail, scoring and bolt collection done by Judges pullers and runners return bolts to competitors.

**Bronze Medal:** 2 competitors (losers from semi) (1 match), competitors shoot A & B detail alternately, scoring and bolt collection done by Judges pullers and runners.

**Gold & Silver Medal:** 2 competitors (winners from semi) (1 match), competitors shoot A & B detail alternately, scoring and bolt collection done by Judges pullers and runners.

A & B details; are determined by the judge tossing a coin and the higher ranked competitor making the call. The winner of the toss makes the decision whether to shoot first (A) or second (B).

### 29.3 Indoor Target

**Name of round:** Indoor 600/25

**Distance:** 18m

**Ends:** 20 ends X 3 Bolts per end = 60 bolts.

**Timing:** 1 minute per bolt = 3 minutes per 3 bolts

**Face:** triple triangular or vertical 25cm multi coloured - 7 zone scoring.

Triple triangular alternative 25cm face the "HiVis Target face (5 zone)" copyright 2002 by Vic Russell. Printed black on Pantone (registered) yellow CVU card. Comprising 5 equal concentric rings from 10 to 6 outwards - the 10, 8 and 7 zones are yellow, with the 9 and 6 rings on black. (These target faces may be printed on an A4 Laser Printer and are available on the WCSA website)

**Practice:** 2 ends of 3 bolts in 5 minutes at the start of the round.

**Name of round:** Indoor 600/40

**Distance:** 18m

**Ends:** 20 ends X 3 Bolts per end = 60 bolts.

**Timing:** 1 minute per bolt = 3 minutes per 3 bolts

**Face:** triple vertical - triangular 40cm multi coloured - 7 zone scoring.

Triple triangular alternative 40cm face the "HiVis Target face (5 zone)" copyright 2002 by Vic Russell. Printed black on Pantone (registered) yellow CVU card. Comprising 5 equal concentric rings from 10 to 6 outwards - the 10, 8 and 7 zones are yellow, with the 9 and 6 rings on black. (These target faces may be printed on an A4 Laser Printer and are available on the WCSA website)

**Practice:** 2 ends of 3 bolts in 5 minutes at the start of the round.

### 29.4 Indoor Match-Play

**Distance:** 18m on 40cm Face

**Ends:** 3 ends X 3 bolts per end per Match = total of 9 bolts per Match.

**Time:** 60 seconds per Bolt = 3 minutes per 3 bolts

**Practice:** On nearby range on same ground so conditions are the same. NO practice shots on the competition range.

**Eliminations:** Start with 16 competitors (8 matches), all shoot together and score - cut to 8 (4 matches), all shoot

together and score

**Finals:**

*Semi*; 4 competitors (2 matches), competitors in each match shoot A & B detail, scoring and bolt collection done by Judges pullers and runners return bolts to competitors.

*Bronze Medal*; 2 competitors (losers from semi) (1 match), competitors shoot A & B detail alternately, scoring and bolt collection done by Judges pullers and runners.

*Gold & Silver Medal*; 2 competitors (winners from semi) (1 match), all shoot together competitors shoot A & B detail alternately, scoring and bolt collection done by Judges pullers and runners.

A & B details; are determined by the judge tossing a coin and the higher ranked competitor making the call. The winner of the toss makes the decision whether to shoot first (A) or second (B).

29.5 **Forest Round**

48 Targets (2 days x 24 targets) with Un-Marked Distances as specified in Section 4, Forest Round

29.6 **3D Round**

48 Targets (2 days x 24 targets) with Un-Marked Distances as specified in Section 5, 3D Round.

## 30 WORLD RECORDS

### 30.1 Types

30.1.1 There will be 3 types of World Records as follows:

- a) World Crossbow Shooting Association **World Championship Records** - those records shot in their respective Divisions at World Championships.
- b) World Crossbow Shooting Association **Regional Championship Records** - those records shot in their respective Divisions at a Regional Championship.)
- c) World Crossbow Shooting Association **Tournament Records** - those records shot in their respective Divisions at tournaments registered with the World Crossbow Shooting Association, eg. World Crossbow Shooting Association Star Tournaments, etc.

### 30.2 Definition

30.2.1 A new record will be established when a score is at least one point higher than an existing Record.

30.2.2 In case of a perfect score shot in Outdoor Target a new record will include the number of clear tens (10s) (circled 10s) and will require at least one more clear ten (10) than an existing Record.

30.2.3 In case of a perfect score shot in the Forest Round a new record will include the number of clear twenties (20s) (circled 20s) and will require at least one more clear twenty (20) than an existing Record.

30.2.4 In case of a perfect score shot in the 3D Round a new record will include the number of clear tens (10s) (circled 10s) and will require at least one more clear ten (10) than an existing Record.

### 30.3 World Records

30.3.1 There will be World Crossbow Shooting Association Medieval Crossbow World Records for Outdoor Target, Outdoor Match-play, Indoor Target, Indoor Match-play, Forest Round and 3D Round for the Divisions of Women, Men, Junior Girls, Junior Boys, Senior Women, Senior Men, Disabled Women, Disabled Men, Guest Women and Guest Men.

**Outdoor Target:**

Individual MC 600 Round (60 bolts);

Individual 40 metres (20 bolts);

Individual 30 metres (20 bolts);

Individual 20 metres (20 bolts);

Individual Double MC 600 Round (2x 60 bolts);

Team MC 600 Round (180 bolts);

Team 40 metres (60 bolts);

Team 30 metres (60 bolts);

Team 20 metres (60 bolts);

Team Double SC 600 Round (2 x 180 bolts);

**Outdoor Match-play;**

Individual 30 metres (6 bolts);

**Indoor Target:**

Individual 25 metres (60 bolts on 60cm faces or 60cm triple triangular/vertical faces);

Individual 18 metres (60 bolts on 40cm faces or 40cm triple triangular/vertical faces);

Individual 18 metres (60 bolts on 25cm faces or 25cm triple triangular/vertical faces);

Team 25 metres (180 bolts on 60cm faces or 60cm triple triangular/vertical faces);

Team 18 metres (180 bolts on 40cm faces or 40cm triple triangular/vertical faces);

Team 18 metres (180 bolts on 25cm faces or 25cm triple triangular/vertical faces);

**Indoor Match-play;**

Individual 18 metres on 40cm face (9 bolts);

**Forest Round:**

Individual 24 Target Unmarked

Individual 48 Target Unmarked (2 rounds x 24 targets)

**3D Round:**

Individual 24 Target Unmarked

Individual 48 Target Unmarked (2 rounds x 24 targets)

### 30.4 Tournaments

30.4.1 All World Championships are considered automatically as World Record Tournaments.

30.4.2 All other tournaments are not automatically considered as World Record Tournaments and need to comply with all the requirements as specified by the World Crossbow Shooting Association .

30.4.3 Team World Records may be established at a tournament at which there is competition between at least One (1) team from each of three (3) different Member Federations.

30.4.4 **World Records can be established in a single Outdoor MC600 Round and a Double Outdoor MC600 Round.** A single Indoor 600/25, a single Indoor 600/40 Round and a combined single Indoor 600/25 and single Indoor 600/40. A Forest Unmarked Round, and a double Forest Unmarked Round. A 3D Unmarked Round, and a double 3D Unmarked Round.

### 30.5 Confirmation of World Records

30.5.1 World Records shot at World Championships are confirmed automatically as soon as the scores at the tournament are official. Records shot at other tournaments are subject to confirmation by the World Crossbow Shooting Association Recorder.

30.5.2 Scores shot at other tournaments must be sent to the World Crossbow Shooting Association Recorder no later than ten (10) days after the tournament.

30.5.3 Anyone can claim a record which must be accompanied by the declaration of the Member Federation under the control of which the tournament was organised, including:

- a) The name, description, place and date of the tournament,.
- b) Confirmation that the tournament was shot under World Crossbow Shooting Association Rules;
- c) Confirmation that a competitor, in respect of whose score, records are being claimed, was a member of either a Member Federation, Member Club or was an Individual Member of the World Crossbow Shooting Association at the time;
- d) Name, nationality and category of the competitor,
- e) A complete results list,
- f) Details of the record claimed, and supported by the original scorecard or a properly certified copy.

30.5.4 The World Crossbow Shooting Association Recorder will ratify a claim for a World Record immediately upon its receipt.

30.5.5 Should a World Record be broken by two or more equal scores made on the same day, the competitors will be declared Joint World Record Holders.

30.5.6 World Record Holders will be presented with a Diploma stating the result and the place of the record

### 30.6 Publication of Records

30.6.1 Records for women and men, girls and boys in each category will be kept separately.

30.6.2 Details of new records will be circulated by the World Crossbow Shooting Association Recorder to all Member Federations and the Executive Council and placed on the World Crossbow Shooting Association website.

## 31 ASSISTED SHOOTERS

### 31.1 General

31.1.1 With the exception of the following rule variations all general rules of shooting shall apply.

31.1.2 There shall be one classification of Assisted Shooter for those people who are physically incapable of standing to shoot in accordance with the general rules of shooting. .

31.1.3 Each Individual Member, Member Federation or Member Club shall be responsible for ascertaining that their entries in these classifications are valid.

**31.1.4 When shooting in the Forest and 3D rounds it is the responsibility of the Assisted Competitor to ascertain the type of terrain to be negotiated and to decide whether they can negotiate it safely. It is also the Assisted Competitors responsibility to provide the necessary equipment and to negotiate the course with their Assistant but without any assistance from the Organisers or Officials.**

### 31.2 Championships

31.2.1 There shall be categories at the World Championships for Assisted Shooters.

### 31.3 Teams

31.3.1 A team shall consist of two shooters.

### 31.4 Shooting Position

31.4.1 A shooter shall sit in or on a seat with their spine above the shooting line and with one set of supporting legs or wheels of their seat on one side of the line and the other set of legs or wheels on the other side. Variation on this shall be permitted where this arrangement is physically impossible.

31.4.2 The seat may take the form of a stool, chair or wheelchair and shall not provide support above the top of the shooter's shoulders.

31.4.3 The arms of a seat shall not provide support to the limbs used to control the bow. If necessary the arms shall be lowered or removed to ensure that the controlling limbs can make no contact with the arms during shooting.

31.4.4 Shooters when using their arms to control the bow shall not rest an elbow on their lap while in the act of shooting.

### 31.5 Assisted Shooter

31.5.1 An Assisted Shooter shall be one who is unable to stand, span the bow or support the weight of the bow unaided.

31.5.2 Assisted Shooters may sit to shoot and may use a stand to support the weight of the crossbow. The shooter may use either one or two limbs to control the bow.

- 31.5.3 The shooter shall have an assistant who shall perform the following functions during shooting:
- a) Bring the bow to the shooting line.
  - b) Span the bow.
  - c) Lift the bow onto the supporting stand before giving control to the shooter.
  - d) Place the bolt in the bow once the shooter has control.
  - e) Return the bow to a point behind the tackle line after shooting of the end.
  - f) Alert the judges to problems during shooting, including calling bouncers and pass through shots.
- 31.5.4 In addition the assistant may assist in getting the shooter to the shooting line and setting up of equipment.
- 31.5.5 While a shot is being made the assistant shall retire to a position 2 metres behind the shooter.
- 31.5.6 The assistant may spot the shots as they are made in order to be able to call a bouncer or a pass through, but shall not inform the shooter of the result until such time as shooting of the end is complete.
- 31.5.7 The assistant may adjust sights but shall only do so under specific instruction of the shooter.
- 31.5.8 The assistant shall represent the shooter in all matters pertaining to the scoring and retrieval of bolts.
- 31.5.9 The shooter may remain on the shooting line in the breaks between the shooting of ends.
- 31.5.10 The stock of the bow shall rest on the support at a point between the back of the prod and the rest position of the string.
- 31.5.11 There shall be no location between the support and the bow other than that provided by gravity.
- 31.5.12 The support shall be fitted with stops to prevent the bow sliding off. The stock may not be held in contact with these stops.
- 31.5.13 No part of the support may protrude above the level of the track.
- 31.5.14 The support shall incorporate a coil spring arranged vertically so as to ensure that it provides support for the weight of the bow but shall not eliminate the requirement for the shooter to stabilise the bow.
- 31.5.15 The shooter shall not deflect the spring so that it reaches the limit of it's possible movement and thus becomes a fixed support.

*See Section 6, Appendix 10 & 11, pageM60 for a picture and diagram of the stand*

# ***SECTION TWO***

## **Safety, Medieval Crossbow, Bolts & Clothing**

## 32 A COMPETITOR'S RESPONSIBILITY FOR SAFETY

- 32.1 Nothing in these Rules, either express or implied, shall remove a competitor's personal obligation to ensure that he/she fully complies with the accepted shooting rule(s), and that no injuries are sustained by others due to any equipment failure, or other negligent act or omission on his/her part on, or near the shooting line. This includes any damage sustained by bolts fracturing, or failing during a competition, or at other shooting event
- 32.2 Crossbow target shooting may be dangerous if careless or lax shooting attitudes and poor tackle maintenance habits are permitted to develop  
Competitors shall not:
- a) use any equipment that is unsafe,
  - b) shoot upward into the air.
  - c) direct a bow loaded or otherwise except at the target provided when it is safe to do.
- 32.3 When required all competitors shall submit their shooting equipment and accessories, including clothing for compliance with safety and other restriction checks.
- 32.4 A competitor submitting equipment, including bolts and accessories for pre-event scrutineering and safety checks, is required to present equipment, etc. that is in good working order, and in full compliance with these Rules.
- 32.5 During equipment scrutineering a competitor may be required to demonstrate in a controlled fashion, that the bow latch and bolt retainer is safe to operate in its offered state, and that the competitor has suitably maintained it in a suitable state of fitness. It shall be an offence to operate any crossbow or use other equipment in an unsafe condition, in which case the equipment will not be permitted to be used.
- 32.6 In Outdoor and Indoor Target Competitors may NOT span, load and raise or aim the crossbow (it must be pointed at the ground, directed towards the competitors designated target and held in a safe position) while on the shooting line before the commencement to shoot signal (1 blast) is given.  
*In the Forest or 3D rounds competitors must keep the crossbow in a safe condition and pointed in the direction of the target while at the shooting post.*
- 32.7 In the interest of personal safety, it is strongly recommended that the fingers of the hand which is loading the bolt be kept straight and pointing towards the front of the crossbow.
- 32.8 The bolt shall only be loaded (nocking) in the crossbow with the crossbow directed to the ground or floor, in front of the shooting line or post and in the direction of the allocated target butt.
- 32.9 Loading a bolt in an elevated crossbow is NOT PERMITTED. Competitors who fail to observe this SAFETY RULE, if repeated after a warning by a Judge will be disqualified and asked to leave the Outdoor, Indoor shooting line or Forest, 3D course and not return.
- 32.10 When a spanned and loaded crossbow is lowered during the act of shooting it must not be turned away from the direction of the allocated target butt.
- 32.11 When the Director of Shooting or Judge signals to stop shooting the crossbow must immediately be lowered, the bolt removed and the safety latch applied.
- 32.12 When the spanned and loaded crossbow is being raised during an Outdoor Target Event it shall only be directed at the competitors designated target and SHALL NOT BE ELEVATED HIGHER than the top of the wind flag. At an Indoor Target Event the bow shall only be directed at the competitors designated target and SHALL NOT BE ELEVATED HIGHER than the top of the butt. On a Forest or 3D Course care must be taken to NOT ELEVATE the crossbow higher than necessary.
- 32.13 If a defect occurs (eg. trigger failure) in the crossbow during the shooting of an end, the competitor must stop shooting immediately, with no further shot taken. If the crossbow is still loaded with a bolt, it must be lowered so that it points to the ground, or floor, in the direction of the competitor's designated target butt, the bolt removed and the crossbow un-spanned (unlatched) if possible. If it is not possible to un-span the bow the safety latch (if fitted) shall be applied. For **Outdoor and Indoor Target** the competitor shall then take one step back (leaving the bow on the shooting line if it cannot be unloaded or unspanned) with a hand or flag held above their head as a signal to the Judge. For Forest and 3D Rounds the competitor shall move back off the shooting line and a Judge shall be called.
- 32.14 If a trigger failure has occurred:  
In Outdoor or Indoor Target the crossbow must be removed from the competition shooting line, and repaired and proved safe, to the satisfaction of the Judges, with test shots on a butt set up at short range (eg 10 - 20 metres) for this purpose before being returned to the competition shooting line. The competitor may repair the equipment but can only make up any missed shots to a maximum of 15 minutes at the end of the distance. In Forest and 3D competitions the crossbow must be removed from the competition shooting line, and repaired and proved safe, to the satisfaction of the Judges, with test shots on a butt preferably at short range (eg 10 - 20 metres) before being returned to the competition shooting line. It may be possible to use a target close to where the failure and repairs occurred depending on the circumstances and the discretion of the Judge concerned without having to leave the course. The competitor has 20 minutes to carry out repairs (excluding test shots) after which time the group will move on to the next target and continue with the competition. While awaiting the 20 minutes repair time the group will stand to one side and permit other groups to pass them. After the 20 minute period the other competitors in the group will start shooting again. In the event that the competitor is unable to complete the repairs to the satisfaction of the judges within the stated time of twenty minutes, they can, after repairs are completed, catch up with their group and continue shooting but are not able to make up any lost shots.
- 32.15 In the event of a prod breakage during an Outdoor or Indoor Target competition, the competitor will **be allowed two (2) sighting shots** (1 end of 3 minutes in which the shots are not scored) before resuming scoring shots. Any missed scoring shots may be made up at the end of the distance being shot to a maximum time of 15 minutes. For Forest and 3D **NO** sighting shots are permitted.

## 33 MIEVEAL CROSSBOW EQUIPMENT

- 33.1 At World Championships, all crossbows shall be checked by the Judges, prior to the start of the event. Any crossbow or associated equipment considered unsafe by the judges will not be permitted to shoot.
- 33.2 Definition and Divisions:  
**The Medieval Crossbow category is to provide competition for those arbalists using a Medieval style crossbow.**  
**There shall be only one recognised Medieval Crossbow equipment Division – "Unlimited". This means that there is no**



distinction between draw weights or style of Medieval crossbow.

33.2.1 Only safe Medieval Crossbows are allowed, provided that they comply with clauses 32.2.2 to 32.2.7 of these rules.

33.2.2 Medieval Crossbows should be of the 1100 to 1500 centuries design. The bow material can be wood, horn, fibreglass, steel or dural aluminium. Fibreglass, Dural Aluminium and any other modern materials on the bow must be covered in authentic natural materials such as hemp, leather etc.

Prod assembly: The prod (bow limbs) may be made of any material and of one piece construction. In the case of metallic prods, the limbs shall be bound with a suitable tape to prevent personal injury in the case of failure.

The trigger must be of a simple mechanical device.

33.2.2 As an Option for safety all Medieval Crossbows may be fitted with:

a). A safety catch or pin which can be set manually or automatically when the crossbow is spanned.

b). An operational bolt retainer which prevents the bolt slipping forward when the crossbow is pointed towards the ground. (In the case of a trackless crossbow, a bolt retainer is not required).

33.2.3 Bow strings and servings must be made from non-metallic materials preferably material similar to the period of the crossbow.

33.2.4 NO sights are permitted

33.2.5 A foot stirrup is allowed and recommended for safety, even if it is not part of the original equipment or design.

33.2.6 The use of spanning (cocking) aids is permitted.

Refer to APPENDIX 1 & APPENDIX 2, Page M55 for picture of bow and diagram of trigger.

## 34 BOLT SPECIFICATIONS

34.1 Medieval Crossbow bolts shall be made from wood and of such design as not to cause unreasonable damage to target butts.

34.2 Points shall be of such shape as to cause as little damage to the target as possible. Either bullet or field point shape are preferred (Broadhead type are NOT permitted).

34.3 Bolts must be fitted with Fletches made of natural materials such as wood, leather or feathers. There is no restriction as to size or number.

34.4 All bolts being shot in an end must have identical fletch sizes and colours with respect to each bolt.

34.5 All bolts shall bear the name or initials of the competitor to whom they belong. Such markings shall be on the shaft.

34.6 **Forest Round:** The bolts shall be numbered in ascending order from number 1 up. The numbering shall be by rings marked around the shaft no less than 2 mm wide and in a colour easily visible on the shaft.

## 35 CLOTHING

### Exhibitions and Demonstrations:

35.1 At all exhibitions and demonstrations medieval/period clothing shall be the preferential clothing worn.

### Target Competitions

35.2 Medieval/period clothing may be worn otherwise clothing must conform to clauses 35.3 – 35.13

35.3 Inclement Weather: Weatherproof clothing made of a single layer of material may be worn during adverse conditions.

35.4 All clothing shall be loose fitting, and shall not give support to any part of the body, track suits may be worn.

35.5 Shooting Hats : Competitors are permitted to wear shooting hats and any other type of hat.

35.6 Sound Dampening Apparatus: Competitors are permitted to wear ear plugs or hearing protectors (headphone type) provided that they do not prevent the wearer hearing acoustic signals.

35.7 Personal Stereo Equipment: The use of personal stereo or radio equipment for music or self-coaching is NOT PERMITTED while on the shooting line in competition or official practice.

35.8 Personal Timers: The use of mechanical or electronic personal timers by competitors or team officials is permitted, provided that NO audible alarm signal is emitted.

35.9 Belts: Competitors are permitted to wear up to two (2) belts, the width of each shall not exceed 30mm. One belt, which **may be firm fitting**, to support clothing (dresses, skirts, slacks, trousers, etc). The second belt, which **must be loose fitting**, to support a quiver.

35.10 Quivers : Bow, Belt or Pocket Quivers are allowed.

35.11 Padded Clothing: The use of special shooting jackets, padded clothing (a single garment, or combination of garments) or accessories so designed to give support or improve performance is NOT PERMITTED all clothing is to be loose fitting.

35.12 Gloves: The use of special shooting gloves is NOT PERMITTED but the wearing of soft flexible gloves (which must be flexible enough so that they can be rolled up by hand into a tight ball) are permitted to be worn during the act of shooting, also the use of finger protection for spanning the crossbow is permitted, this must be removed during the act of shooting.

35.13 Normal shoes or sports shoes which do not enclose and/or give support to the ankle shall be worn at all times during outdoor target and indoor target, competitions. Soft rubber boots and over-shoes are permitted in adverse weather conditions. Such boots or overshoes may not give support or aid performance by restricting ankle movement).

### WCSA Forest and 3D Competitions:

35.11. Footwear suitable for the terrain which enclose and/or give support to the ankle may be worn.

35.12 Binoculars may be used for spotting bolts. There shall be nothing in the optical system which may aid in determining distance.

35.13 Shooters are encouraged to wear smart, tough outdoor clothing suitable for the conditions and course. The wearing of high-visibility clothing is encouraged.

**Camouflage clothing is NOT PERMITTED on the Forest and 3D courses for safety reasons.**

# **SECTION THREE**

## **Outdoor Target**

## **Outdoor Match-play**

## 36 OUTDOOR TARGET

### 36.1 Range Layout

- 36.1.1 The shooting direction is to be within +/- 20 degrees of north in the Northern Hemisphere and of south in the Southern Hemisphere.
- 36.1.2 The grounds and the location of the targets shall provide substantially equal conditions for all competitor's. All competitors shall be accommodated on the same range.
- 36.1.3 The range will be squared off and each distance will be accurately measured from a point vertically beneath the centre (gold) of each target face to the shooting line along the ground (for three target faces per target at 130cm centre). Tolerances on distances shall be +/- 15cm.
- 36.1.4 The targets shall be inclined backwards such that the angle from vertical is about 10 to 15 degrees with all targets appearing uniform
- 36.1.5 Provision will be made for sufficient targets to allow for not more than two competitors per target.
- 36.1.5.1 With one competitor per target the centre of the face will be 130cm (tolerance of measurement will not exceed +/- 5cm) above the ground as measured from an estimated even ground level. The face will be placed in the centre of the target butt (*Refer Section 6, Appendix 4*). The height of the centres of the faces in a line of target butts, on the range should look straight at all times.
- 36.1.5.2 With two competitors per target (two face set-up) the centre of the faces will be 130cm (tolerance of measurement will not exceed +/- 5cm) above the ground as measured from an estimated even ground level. Each of the faces will be placed in its half of the target butt (*Refer Section 6, Appendix 4*) and the minimum distance between the scoring zones of the faces will be 1cm. The height of the centres of the faces in a line of target butts, on the range should look straight at all times.
- 36.1.6 Targets butts shall be spaced such that there is at least 1.5m per competitor per detail per target butt,
- 36.1.7 A point on the shooting line directly opposite each target face will be marked and there shall be a number corresponding to that target face positioned 2m in front of the shooting line.
- 36.1.8 Shooting lanes shall be at right angles to the shooting and target lines, the width of each being sufficient to accommodate all the competitor's on each target butt in each lane which may contain one or two butts. Lanes shall be marked on the ground from the shooting **line to the 40m target line.**
- 36.1.9 A **target line shall be marked on the ground at 20, 30 and 40m distances, parallel to the shooting line**
- 36.1.10 A waiting line should be indicated at least five metres behind the shooting line
- 36.1.11 An equipment area shall be from the waiting line, to a line 2m behind the waiting line.
- 36.1.12 A spectator line should be indicated at least ten metres behind the waiting line,
- 36.1.13 The field should, be marked or roped-off and only competitor's taking part in the event and persons otherwise authorised shall be allowed to enter. Spectators should be required to be at least ten metres behind the waiting line
- 36.1.14 **Where the public has the right of access, suitable barriers must be erected around the range to keep spectators back. These barriers will be at least 18 metres away from the ends of the target line set at 40 metres and may, if desired, reduce in a straight line to a minimum of 10 metres away from the ends of the Shooting Line. This would maintain a margin of approximately 15 metres from the target line when the target butts are moved forward to 20 metres. The barriers will be at least 10 metres behind the waiting line and as far beyond the target line set at 40 metres to prevent members of the public passing closer than 65 metres behind the target butts. This will create a safety zone increasing to 85 metres when target butts have been moved forward to shoot 20 metres. The safety distance of 65 metres may be reduced when an adequate backstop, e.g. efficient netting, bank or similar device, is erected (not a hedge or penetrable fence). Such a backstop must be high enough to stop bolts, which have just missed the top of the butt at 40 metres.** Consideration should be given to any distractions caused to the competitors by movement of people, etc. behind the butts.
- 36.1.15 Traffic lights are to be placed on both sides of the field and, if necessary, in a clear lane in the centre of the target butts so that both right and left handed competitors will be able to see them. They are to be placed in front of the shooting line on each side of the field and in the clear lane at any distance shorter than **20 metres**, as long as they are visible to all competitors on the shooting line.
- 36.1.16 A recommended layout for World Outdoor Target Championships Tournaments is shown in *Section 6, Appendix 3*

### 36.2 Venue Equipment

#### 36.2.1 Targets (Buttresses)

The front of the buttress shall encompass a circle or square of at least 124 x 85cm (for two target faces) or 85 x 85cm (for one target face), this will ensure that any bolt hitting the butt and just missing the outermost edge of the scoring zone remains in the butt. The butt is to be made from suitable material such that bolts will not ordinarily rebound from, pass through or be damaged by it.

- 36.2.2 The target butt shall be supported and secured on a suitable framework so that its centre is 130 cm  $\pm$  5 cm above the average surrounding ground level. The Butts and the framework will be secured to the ground in such a manner as to prevent them from being blown over or collapsing. Particular care must be taken when more than one target face is placed on the butt, that bolts passing through the butt are not damaged by the support. (*Refer target butt drawing Section 6, Appendix 5*).
- 36.2.3 The target shall be inclined backwards such that the angle from vertical is about 10 to 15 degrees with all targets appearing uniform.
- 36.2.4 A wind indicator flag shall be fitted to each target, such flags shall be of any light material and colour and shall be positioned above the centre of each butt high enough to allow a clearance of a minimum of 5cm between the bottom of the flag strips and the top of either the buttress or the target number, whichever is the higher. (*Refer section 6, Appendix 5 for diagram of wind indicator flag*).
- 36.2.5 Target faces shall be numbered. The numbers shall be 30cm tall and shall be black figures on a yellow background, alternating with yellow figures on a black background (eg. No. 1 black on yellow, No. 2 yellow on black, etc.). Target numbers shall be affixed above the centre of each target face. (*Refer target face/butt drawing Section 6, Appendix 4*).
- 36.2.6 Flags or some other suitable device, shall be provided at the targets and on the shooting line with which competitors

and/or scorers can signal for a judge. These flags shall preferably be red in colour.

### 36.3 Target Faces

36.3.1 The standard face shall be divided into five equal concentric coloured rings arranged from the centre outwards as follows; gold (yellow), red, light blue, black and white. Each ring shall in turn be divided by a thin line into two zones of equal width, thus making ten scoring zones. The inner gold zone may be further divided with a line at 50% of the diameter of this zone. Such dividing lines, and any dividing lines which may be used between colours, shall be made entirely within the higher scoring zone in each case.

Any line marking the outmost edge of the white shall be made entirely within the scoring zone.

The width of the thin dividing lines as well as the outermost line shall not exceed 2mm.

The centre of the target face is termed the 'pinhole' and shall be indicated by a small "+" (cross) the lines of which shall not exceed 1mm in width and 4mm in length

36.3.2 Recognised target face shall be 60cm in diameter (*Refer Section 6, Appendix 7*).

36.3.3 Competitors will be provided with their own individual target face. Each face shall be affixed with a number to indicate the assigned target face to the competitor. The numbers shall be affixed as in rule 36.2.5

36.3.4. The target face shall be affixed to the target in such a manner that the face cannot move or contract when hit by a bolt.

36.3.5 Target faces may be made of paper, cloth or any other suitable material. All faces shall be uniform and of the same material. Only those faces as approved by the World Crossbow Shooting Association or licensed by the International Archery Association (FITA) shall be used.

#### Tolerances of measurement

Zone	Diameter in cm 60cm Face	Tolerance +/- in mm
Inner 10	3	1
Outer 10	6	1
9	12	1
8	18	1
7	24	3
6	30	3
5	36	3
4	42	3
3	48	3
2	54	3
1	60	3

#### Scoring values and Specifications

Scoring Values	Colours	Pantone Scale
10	Yellow	107U
9	Yellow	107U
8	Red	032U
7	Rd	032U
6	Light Blue	306U
5	Light Blue	306U
4	Black	Process Black
3	Black	Process Black
2	White	
1	White	

### 36.4 Time Control Equipment

36.4.1 Acoustic and visual

36.4.1.1 The Director of Shooting (see article 7.7.1) will control:

- the start and end of each time limit with an audible device.
- each time limit with digital clocks, lights, flags, plates and/or any other simple visual device in addition to the audible signal referred to above.

36.4.1.2 In the event of any discrepancy between the acoustic and the visual time control equipment, the acoustic time control equipment will take precedence

36.4.2 The following equipment can be used.

#### 36.4.2.1 Lights

The colours of the lights will be red, amber and green in that order with the red at the top. The lights must be synchronised and at no time will two different colours be on at the same time. The lights must be linked with the acoustic equipment so that the first sound of the acoustic equipment is simultaneous with the light turning red and the digital clock reaching zero.

#### 36.4.2.2 Digital Clocks

When timing is controlled by the use of digital clocks the figures on the clock will be a minimum of 20cm in height and must be able to be clearly read at a distance of 100m. They must be able to be immediately stopped and reset as may be required. The clock must function on a count down principle.

All other requirements, e.g. position, number, etc., will be the same as for lights.

When digital clocks and lights are used they must be synchronised. If there is a discrepancy between the digital clock and lights, the digital clock takes precedence

#### 36.4.2.3 **Manual Timing**

When the time limit is controlled manually by means of plates these plates are to be not less than 120cm by 80cm in size. They must be securely mounted to resist any wind and must be easy to turn quickly to show either side. One side of the plates will be striped with 20-25cm wide stripes alternating in black and yellow. The stripes will be at an angle of about 45 degrees to the ground. The reverse side will be all yellow. (*Refer Section 6, Appendix 6*)

#### 36.4.2.4 **Emergency Equipment**

When the time limit is controlled by electrical equipment, plates, flags or other simple manual devices must be available in case the electrical equipment fails. Lights and/or digital clocks and emergency equipment are mandatory for WCSA Championships.

### 36.5 **Miscellaneous Equipment**

The equipment outlined below is mandatory for WCSA Championships and is recommended for other important tournaments.

36.5.1 Registration numbers to be worn by each competitor.

36.5.2 A raised platform with seating facilities for the Director of Shooting.

36.5.3 Loudspeaker equipment, is recommended at large tournaments.

36.5.4 Equipment such as Field Telephones, "walkie-talkies" and the like are most useful for communication between officials.

36.5.5 A device to indicate the order of shooting; e.g. A B; B A; A B; etc. if the competitors do not all shoot at the same time. The letters will be large enough to be read by all competitors from their respective shooting positions. Two or more of these devices may be needed.

36.5.6 Sufficient chairs or benches behind the waiting line for all competitors, Team Captains, Judges and other officials.

36.5.7 One large scoreboard for progressive totals after each end, for at least the first eight women and first eight men Juniors, Seniors and Assisted and which indicate the scores

The large scoreboard may be supplemented by displaying the progressive scores of all competitors after each end by a device situated on the ground in front of the target butt.

36.5.8 A score board or some other such device with the competitor's name and/ or target number 1A, 1B or simply A, B may be used for displaying progressive total scores after each end. When this device is being used, it will be placed on the ground below and in front of each butt. It must be pegged or fixed securely to prevent movement by wind. It will be changed by the appointed scorer, aided by the competitors on that target butt, after the bolts have been scored and drawn, and before they leave the target butt.

### 36.6 **Shooting Control and Safety**

36.6.1 A Director of Shooting will be appointed. Whenever possible this will be a Judge. He will not participate in the shooting. Assistants may be appointed as necessary at the discretion of the Organising Committee to assist the Director of Shooting in the execution of all the duties.

36.6.2 The Director of Shooting will institute and enforce any reasonable safety measures he considers necessary.

36.6.3 A competitor arriving after shooting has started will forfeit the number of bolts already shot, unless the Director of Shooting is satisfied that the competitor was delayed by circumstances beyond his or her control. In this case the competitor may be allowed to make up the lost bolts after the distance then being shot is completed, but in no circumstances may that be more than 15 minutes.

36.6.4 The Director of Shooting, in consultation with the Judges, has authority, to extend the time limit in exceptional circumstances. Any such special ruling introduced must be announced to the competitors before having effect. In such cases, the final results list must include the special ruling and the reasons for it. When visual time controls are in use, the thirty seconds remains unchanged,

36.6.5 Shooting shall not commence unless safety conditions have been endorsed by the Judges and Director of Shooting.

36.6.6 The Director of Shooting shall give a fifteen (15), ten (10), five (5) and two (2) minute warning before the start of competition shooting.

36.6.7 At the commencement of each end two (2) sound signals for the competitors to occupy the shooting line.

36.6.8 The signal to commence shooting shall be one (1) sound signal.

36.6.9 The signal to cease shooting and retire to the waiting line shall be two (2) sound signals. When competitors are shooting in details, this is also the signal to allow the next detail to move to the shooting line.

36.6.10 The signal to score and collect bolts shall be three (3) sound signals..

36.6.11 A series of sound signals shall indicate danger and all shooting must cease immediately on the first sound signal. The signal to resume shooting shall be one (1) sound signal.

36.6.12 After the start of an end all shooting shall stop on the first sound signal.

36.6.13 Whenever the shooting line is clear, with all competitors having finished shooting their bolts before the end of the time limit, the appropriate signal for change or scoring will be given immediately.

36.6.14 No competitor will occupy the shooting line except when the appropriate signal has been given

36.6.15 Competitors may NOT span, load and raise or aim the crossbow (it must be pointed at the ground, directed towards the competitors designated target and held in a safe position) while on the shooting line before the commencement to shoot signal (1 blast) is given.

36.6.16 A competitor may not span or load a crossbow with a bolt, except when standing on the shooting line and under the control of the Director of Shooting. A competitor may check his/her stance/position on the shooting line, by lifting the crossbow (which is not to be spanned or loaded with a bolt) and shall only aim towards his/her target, but only after being satisfied that the field is clear both in front of and behind the targets. If a competitor, whilst checking his/her

stance/position on the shooting line, before the shooting starts or during breaks between distances, looses a bolt, intentionally or otherwise, will be disqualified and removed from the competition on the matter of safety.

- 35.6.17 While shooting is in progress only those competitors whose turn it is to shoot may be on the shooting line. All other competitors shall remain behind the waiting line with their equipment. Spotting telescopes may be left on the line at the discretion of the Director of Shooting.
- 36.6.18 After a competitor has shot his/her bolts, he/she shall retire behind the waiting line with his/her equipment. A competitor confined to a wheelchair may be permitted to remain on the shooting line provided that it does not interfere with the conduct of the Tournament.
- 36.6.19 No competitor or other person may touch the tackle of another without the latter's consent.
- 36.6.20 A competitor shall not be disturbed or approached during shooting except in an emergency.
- 36.6.21 No person shall approach a target or go forward of the shooting line unless the Director of Shooting has signalled permission to do so.
- 36.6.22 To ensure the proper conduct of a tournament and in the interests of safety, the Director of Shooting or Judges may request a competitor to change his/her shooting position on the line or join another target group. If the competitor considers the Director of Shooting or Judges' request to be unreasonable his/her appeal to the Jury of Appeal shall be heard prior to any change in position.
- 36.6.23 Any remark or action made that may cause annoyance or confusion to a competitor or may detract from his/her concentration is un-sportsmanlike and is not allowed. The Judge(s) shall first caution the offender, and if the offence is repeated, may direct him/her to withdraw from the event.
- 36.6.24 In the event of a competitor not being satisfied with a ruling given by the Judges, he or she may, except as provided for in rule 36.9.4 below, appeal to the Jury of Appeal according to rule 36.11. Trophies or prizes which may be affected by a dispute will not be awarded until the Jury ruling has been given.
- 36.6.25 Should a target face become unreasonably worn or otherwise disfigured, or should there be any other complaint about range equipment, A competitor or his Team Manager may appeal to the Judges or Director of Shooting to have the defective item replaced or remedied.

### 36.7 Order of Shooting and Timing Control

- 36.7.1 A shooting time limit shall be applied, such time limit shall be three minutes for **two (2) bolts**. Any bolts not shot after this time shall be lost. If any bolt is shot outside the time limit for an end, the competitor's highest scoring bolt for that end shall be forfeited.
- 36.7.2 When the shooting is controlled by plates: two plates are essential in the clear lane so that the same side of the plates (all yellow or black & yellow stripes) is displayed simultaneously to all competitors. The BLACK and YELLOW striped side will be turned towards the competitors as a signal of warning that only thirty (30) seconds are left of the time limit. The YELLOW side of the plate will be turned toward the competitors at all other times.
- 36.7.3 When shooting is controlled by Lights.
- RED** The Director of Shooting shall give two sound signals for the designated competitors to occupy the shooting line all together.
  - GREEN:** On the lights changing Green (20 seconds after the 2 sound signals) the Director of Shooting will give one sound signal for shooting to start.
  - YELLOW** This light will go on when only 30 seconds are left of the time to shoot.
  - RED:** Means that the Time Limit has expired and two sound signals will be given to indicate that the shooting is to stop, even if all bolts have not been shot. Any competitor still on the shooting line, must immediately lower the crossbow, remove the bolt from the bow and the string un-spanned (unlatched and lower the string), and retire behind the waiting line. If shooting in details, the next detail will move up and occupy the shooting line and wait for the Green light, as above for the shooting to begin, the above procedure will be repeated until all have shot. When all competitors have shot an end of three bolts the RED light will come on and three sound signals will be give for the competitors to go forward and score.
- 36.7.4 If shooting in two (2) or more details, 20 seconds is the time allowed for those competitors left on the shooting line to retire and the competitors in the next detail to occupy the shooting line. If all competitors are shooting together in one detail 20 seconds is the time allowed to occupy the shooting line.
- 36.7.5 When the Director of Shooting has ascertained that all competitors have completed shooting and retired behind the waiting line or the time limit has expired, three (3) sound signals will be given as the signal to proceed without undue haste to the targets to score, recover bolts, and return to the waiting line.
- 36.7.6 When all competitors are ready to shoot again the Director of Shooting shall signal the start of the next end with two (2) blasts to move to the shooting line followed by one (1) blast to commence shooting. This method shall continue until the round is completed. After completing the required number of ends at one distance the competitors shall proceed to the next distance.
- 36.7.7 When shooting is suspended during an end for any reason, the time limit will be adjusted according to the number of bolts remaining and the period of time permitted. eg: sixty seconds per bolt.
- 36.7.8 Competitors on a target may be divided into shooting details, for example A,B etc., shooting at different times.

### 36.8 Shooting

- 36.8.1 Two (2) ends of practice (**2 x 2 bolts in 5 minutes**) shall be made available to all competitors immediately before commencement of the first scoring end of the event and conducted under the control of the Director of Shooting.
- 36.8.2 There shall be a minimum of 30 minutes break between distance changes.
- 36.8.3 There shall be one end of practice (**2 bolts in 5 minutes**) at each distance change.
- 36.8.4 In the case of several rounds comprising a tournament or event there shall be practice at the commencement of each round
- 36.8.5 When a round is shot over several days there shall be practice available at the commencement of each day.
- 36.8.6 A bolt shall not be deemed to have been shot if

- a) the competitor can touch it with his/her bow without moving his/her feet from their position in relation to the shooting line, in which case another bolt may be shot in its place. If another bolt is not available the competitor may retrieve his/her bolt with the Judges' permission.
  - b) the target face or buttress falls over (in spite of having been fixed and pegged down to the satisfaction of the Judges. In this case, the Judges will take whatever measures they deem necessary and compensate adequate time for shooting the relevant number of bolts. If the buttress only slides down it will be left to the Judges to decide what action to take, if any.
- 36.8.7 In the event of equipment failure the competitor shall step back off the shooting line (approx 0.5m) and at the same time call a Judge using a flag or other device provided for the purpose, or by holding a hand and arm in the air above the head. The competitor will be allowed a maximum of 15 minutes extra time to shoot any make up bolts, one minute per bolt in **2 bolt ends**, No extra time will be allowed in the case of a bolt defect (ie. Damaged nock, loose vane etc.)
- 36.8.8 In the event of a competitor being unable to continue shooting because of an unexpected medical problem which occurs after the beginning of the shoot, no more than 15 minutes will be allowed for medical personnel to determine the problem and decide whether or not the competitor is fit to continue competing unassisted. The competitor will make up the appropriate number of bolts at the earliest opportunity under the supervision of the Director of Shooting but has a maximum of 15 minutes to do so.
- 36.8.9 During the act of shooting, a competitor shall have one foot wholly behind the shooting line, or both feet on the shooting line. However, a competitor who is physically handicapped may shoot from a chair or otherwise in such a position that half of their body is behind the shooting line.
- 36.8.10 In the event of a competitor leaving bolts on the ground or in the target, they may use others provided they inform a Judge before shooting. In such circumstances, a Judge shall participate in the scoring of that end, making sure that the bolts which remained in the target are checked back to the competitor's score sheet before any bolts are withdrawn from the target.
- 36.8.11 Competitors shall take spare bolts with them to the shooting line and shall not leave the shooting line during their shooting time, except for reasons expressly permitted within these rules.

### 36.9 Scoring

- 36.9.1 The scoring zone values shall be 10, 9, 8, 7, 6, 5, 4, 3, 2, and 1 from the centre outwards with clear tens (10s) (a 10 not touching the outer 10 scoring zone line) being marked on the score sheet with a circle around it. A miss is marked as an X.  
The clear tens (10s) are used in tie breaking.  
Where partial target faces are in use, the scoring values shall be 10, 9, 8, 7 and 6 from the centre outwards with the same qualification on the clear tens (10s).
- 36.9.2 Neither the bolts nor the face shall be touched until all bolts on that target have been recorded.
- 36.9.3 A bolt shall be scored according to the position of the shaft in the target face.
- 36.9.4 Any competitor on the target shall refer any questions about the value of a bolt in the target to a Judge before the bolts are drawn. The Judge's ruling is final.
- 36.9.5 A mistake on a score sheet discovered before the bolts are drawn may be corrected, but the correction must be made and initialled in red by a Judge before the bolts are drawn. If the bolts have been drawn, no corrections to the bolt values as written on the score sheet shall be permitted. Any other disputes concerning entries on a score sheet shall be referred to a Judge.
- 36.9.6 Should the shaft of a bolt touch two colours, or touch any dividing line between scoring zones, that bolt shall score the higher value of the zones affected.
- 36.9.7 Should a fragment of a target face be missing which includes a dividing line or where two colours meet or if the dividing line is displaced by a bolt, then an imaginary line shall be used for judging the value of any bolt that may hit such a part.
- 36.9.8 Bolts embedded in the buttress and not showing on the face, should only be scored by a Judge.
- 36.9.9 Except as provided for in 36.8.10, if more than two bolts belonging to the same competitor should be found in the target or on the ground in the shooting lanes either in front of or behind the target, only the three lowest in value shall be scored.  
Should a competitor be found to repeat this, he/she may be disqualified.
- 36.9.10 A bolt hitting:
- a) the target and rebounding, the competitor concerned shall complete the shooting of that end of (2) two bolts, and shall take one step back( approx 0.5m) from the Shooting Line with his free hand held aloft holding the signal flag as a signal to a judge, who shall then carry out the following procedure.  
When all the other competitors have completed shooting that end of two (2) bolts or the time limit has expired, whichever is appropriate, the Director of Shooting shall interrupt the shooting sequence. A Judge, having satisfied himself that the claim was justified, shall allow the competitor concerned to shoot another bolt.  
The bolt shall be numbered or marked by the judge in such a way, which will enable it to be identified in the target. At a signal from the Judge, the Director of Shooting shall give the signal for the competitors and scorers to advance to the targets for scoring.  
The judge shall participate in the scoring and ensure that the correct number of bolts are scored and that the Rebound was not caused by striking another bolt in the target, In such case, 36.9.10 b) will apply,
  - b) Another bolt: A bolt laying on the ground in front of the butt which is believed to have struck another bolt already in the target, and rebounded shall score the value of the bolt struck, provided the struck bolt is found in the target with its nock or shaft damaged in a compatible manner.
  - c) the target and rebounded from or passed through it is found lying on the ground (when going to score) behind or in front of the target, it shall not be picked up before the Judge(s) have seen it,

who being satisfied that the bolt has passed through the target or rebounded from it and not from striking another bolt. In such a case they shall allow the competitor concerned to shoot another bolt, at the end of the next end, as in rule 36.9.10.a) or if it is the last end of a distance before the butts are moved.

- d) the target and hanging from it, shall oblige the competitor on that target to stop shooting and signal in the same way as in 36.8.7. When the shooting of that end has been completed by the other competitors on the line, or the time limit has expired, whichever is appropriate, a Judge shall note the value of the bolt, remove it, and place the bolt behind the target. The remaining bolts shall be shot by the competitor on that target before the Director of Shooting orders general shooting to recommence. The Judge concerned shall participate in the scoring of that end;
- e) another bolt remaining embedded therein, shall score according to the value of the bolt struck.
- f) another bolt, and then hitting the target face after deflection, shall score as it lies in the target face,
- g) a target face other than a competitor's own target face shall not score.

36.9.11 Competitors may delegate the authority to score and collect their bolts to another competitor on their own target or other person provided that they themselves do not go up to the target.

36.9.12 Scorers shall enter on score sheets and in descending order the value of each bolt as called out by the competitor to whom the bolts belong. Other competitors with that scorer shall check the value of each bolt called out. Only bolts scoring ten points shall be referred to as "Golds". Scorers should compare their scores before any bolts are drawn.

36.9.13 On completion of a distance or an event, as required, score sheets shall be signed by the scorer and the competitor, denoting that the competitor agrees with the value of each bolt. If the scorer is participating in the shooting, his score sheet shall be signed by another competitor with the same scorer.

36.9.14 An incorrectly totalled score sheet shall be corrected. Where double scoring is used and a discrepancy between the score sheets is found after bolts have been removed from the target face, the lowest recorded values of the bolts shall be credited.

36.9.15 The Director of Shooting will ensure that, after scoring, no bolts are left in the targets before any signal is given for shooting to recommence. If this inadvertently happens, the shooting shall not be interrupted and the competitor concerned may shoot that end with other bolts after informing a judge, or make up the bolts lost after shooting over that distance has been completed.

In such circumstances, a Judge shall participate in the scoring of that end, making sure that the bolts which remained in the target are checked back to the competitor's score sheet before any bolts are withdrawn from the target.

36.9.16 A scoring board or some such device with the competitors' names and/or target numbers is permitted for displaying progressive and/or total scores after each end.

## 36.10 Ties

In the event of a tie in score, the results shall be determined as follows:

### For individuals-

- a) The competitor, of those tying, with the greatest number of scoring hits.
- b) If this is a tie, then the competitor of those so tying with the greatest number of Centre Tens or Ring Tens.
- c) If this is also a tie, then the competitor of those so tying with the greatest number of golds (hits scoring 10 points).
- d) If this is also a tie, then the competitors so tying shall be declared equal.

### For Teams:

- a) The team, of those tying, having the competitor making the highest individual score.
- b) If this is also a tie, then the team of those so tying having the competitor making the second highest individual score.
- c) If this is also a tie, then the teams so tying shall be declared equal.

## 36.11 Questions, Disputes and Appeals

36.11.1 Questions concerning the conduct of the shooting or the conduct of a competitor must be lodged with the Judges before the next stage of the competition

36.11.2 Appeals against rulings by the Judges, Director of Shooting or Tournament Officials must be presented in writing to the Jury of Appeal the same day. No appeals can be made against the value of a bolt.

36.11.3 Appeals against the conduct of the shooting or the conduct of a competitor shall be lodged in writing with the Judges or Tournament committee the same day.

36.11.4 Queries/Questions regarding daily published results shall be lodged with the Organising Committee without any undue delay, and in any event must be lodged in time to allow corrections to be made prior to any prize giving.

36.11.5 When the awarding of trophies or prizes may be affected by an appeal or appeals, they shall not be awarded until the Jury ruling has been given.

36.11.6 Should a target face become unreasonably worn or otherwise disfigured, or should there be any other complaint about range equipment, a competitor or his Team Manager may appeal to the Judges or Director of Shooting to have the defective item replaced or remedied.

36.11.7 Competitors on the target shall refer any questions about the value of a bolt in the target to a Judge before the bolts are drawn.

36.11.8 A mistake on a scoresheet discovered before the bolts are drawn may be corrected, but the correction must be made and initialled by one of the Judges before the bolts are drawn. If the bolts have been drawn, no corrections to the bolt values as written on the scoresheet shall be permitted. Any other disputes concerning entries on a scoresheet shall be referred to a Judge.



### 36.12 Jury of Appeal

*For World Championships refer to Section 1, clause 20.*

- 36.12.1 A Jury of Appeal of three members shall be appointed by the Organising Committee. Persons participating in the Championships are not eligible for the Jury of Appeal. Members of the Jury of Appeal shall preferably be persons with experience and a good knowledge of the sport and rules. Where a Jury of Appeal has not been appointed, the Organising Committee shall assume this role.
- 36.12.2 Appeals must be presented, in writing, by Team Managers, or appellants if no Team Manager has been designated or they are individual member competitors. No appeal can be made against the value of a bolt. An intention to appeal when it might affect the progression of a competitor from one stage of the competition to the next must be expressed in writing and lodged with the chairperson of the Tournament Judge Commission within 5 minutes of the end of the match. The written appeal must be lodged with the Jury in time to allow the Jury to come to a decision before the beginning of the next stage of the competition.
- 36.12.3 The Jury must be available at the Tournament grounds at all times during the Tournament or event (including the day of official practice) until thirty minutes after the end of shooting.
- 36.12.4 Jury decisions shall be minuted and submitted to the appellant, the Chairperson of the Tournament Judge Commission and the Organising Committee before the beginning of the next stage of the competition or before the awarding of prizes. The ruling of the Jury of Appeal shall be final.
- 36.12.5 **Protest Fee**  
All appeals must be submitted in writing not later than one hour after the close of the days shooting and before any prize giving and be accompanied by a fee if one is applied by the Organising Committee (*for World Championships Refer to Section 1, clause 20*). The fee applied shall be returned if the appeal is upheld and shall be retained by the Organising Committee if the appeal is lost.
- 36.12.6 Decisions made by the Jury of Appeal must be documented and submitted to the appellant, the Chairman of the Judges Commission and the Chairperson of the Organising Committee before the awarding, of prizes or the next stage of the competition as the case may be. This terminates the path of appeal.

### 36.13 Director of Shooting

- 36.13.1 A Director of Shooting and a Deputy will be appointed.
- a) Whenever possible they will be Judges. They will not participate in the shooting or have other tasks during the hours of the shooting.
  - b) Assistants may be appointed as necessary at the discretion of the Organising Committee to assist the Director of Shooting and the Deputy in the execution of all their duties.
- 36.13.2 The Director of Shooting will institute and enforce any reasonable safety measures he/she considers necessary, his duties include,
- a) Controlling the shooting, regulating the timing of ends, and the order in which the competitors will occupy the shooting line
  - b) Exercising control over the use of the loudspeaker equipment, the activities of photographers, etc., so that competitors are not disturbed,
  - c) Ensuring that spectators remain behind the barriers enclosing the shooting range.
  - d) In the case of an emergency giving a series of not less than five sound signals for all shooting to cease. If shooting is suspended during an end for any reason, one sound signal will be given for shooting to re-continue;

### 36.14 Judges

- 36.14.1 The Judges' duties are to ensure that the tournament is conducted according to the World Crossbow Shooting Association Constitution & Rules, and in fairness to all competitors.
- 36.14.2. Where possible at least one Judge for every ten target butts in Outdoor Target will be appointed. However there must always be a minimum of three judges. Their duties will be as follows:
- 36.14.2.1 They will;
- a) check all distances and the correct layout of the range;
  - b) check the dimensions of target faces and target butts;
  - c) check that the faces are set at the correct height from the ground or floor,.
  - d) check that all butts are set at a uniform angle.
  - e) check all the necessary venue equipment;
  - f) check all competitors' equipment before the Tournament (time to be stated on the tournament program) and at any time thereafter during the Tournament,
  - g) control the conduct of the shooting;
  - h) control the conduct of the scoring;
  - i) verify the scoring in the Elimination and Finals Rounds
  - j) consult with the Director of Shooting on questions, which arise regarding the handling of any disputes and appeals which may arise and, where appropriate, pass them on to the Jury of Appeal;
  - k) in liaison with the Director of Shooting, interrupt the shooting if necessary, use of weather conditions, power failures, a serious accident, or other occurrences, but to ensure if at all possible, that each day's program is completed on that day,
  - l) consider relevant complaints or requests from Team Managers and where applicable to take suitable action. Collective decisions will be made by a simple majority of votes. In case of a tie, the Chairman will have a tie-breaking vote;

- m) deal with questions concerning the conduct of the shooting or the conduct of a competitor. These questions must be lodged with the Judges without any undue delay and in any event must be lodged before the prize giving. The ruling of the Judges or Jury of Appeal, as applicable, will be final.
- n) make sure that at no time will any equipment failure delay the tournament by more than 15 minutes
- o) control that all competitors and officials conform with the World Crossbow Shooting Association Constitution and Rules as well as decisions and directives the Judges may find necessary to make. A competitor proved to have transgressed any rules and regulations knowingly may be ruled to be not eligible to participate and be eliminated and will lose any position he/she may have gained.

### 37 MATCH-PLAY

**Distance: 30m**

**Ends:** 3 ends X 2 bolts per end per Match

**Time: 90 seconds per Bolt = 3 minutes per 2 bolts**

**Practice:** On nearby range on same ground so conditions are the same. NO practice shots on the competition range.

**Eliminations:** Start with required number of competitors, all shoot together and score - cut in half, all shoot together and score, continue until the finals quantity is reached

#### Finals:

*Semi;* 4 competitors (2 matches), competitors in each match shoot A & B detail alternately, scoring and bolt collection is done by Judges and Competitors Agents with Runners to return bolts to competitors. The competitors do not move up to the targets.

*Bronze Medal;* 2 competitors (losers from semi) (1 match), competitors in each match shoot A & B detail alternately, scoring and bolt collection done by Judges and Competitors Agents with Runners to return bolts to competitors. The competitors do not move up to the targets.

*Gold & Silver Medal;* 2 competitors (winners from semi) (1 match), all shoot together competitors shoot A & B detail alternately, scoring and bolt collection done by Judges and Competitors Agents with Runners to return bolts to competitors. The competitors do not move up to the targets.

*A & B details;* are determined by the Judge tossing a coin and the higher ranked competitor making the call. The winner of the toss makes the decision whether to shoot first (A) or second (B).

*Competitors Agent;* The Competitor selects an agent to represent him/her at the target. Their duty is to act on behalf of the competitor at the target by checking the score called and recorded is correct, to sign the score sheet on behalf of the competitor, to mark the bolt holes and to pull the bolts from the target butt.

- 37.1 Match-play is a series of knock-out matches between two (2) competitors. The winner of each match moving to the next round and the loser leaving the competition, finishing with the competitor who was not beaten in the last round match being declared the winner. (Refer chart at Section 4, Appendix 10).
- 37.2 **It is mandatory at World Championships** to start with the top sixteen (16) competitors in each division. Eight (8) if there are not enough competitors to make up the 16 and four (4) if there are not enough competitors to make up the 8. Any less than four (4) and the match-play competition for that division will be cancelled.
- 37.3 At any other competition the match-play may be conducted with more competitors but the number to start with must be capable of being halved each round until it reaches the final 2 competitors in the final match. For example:- 256, 128, 64, 32, 16, 8, 4, 2.
- 37.4 All the rounds down to the ones with 4 or 2 competitors are known as the Elimination Matches which may be shot all together in each round. The rounds with 4 or 2 competitors are known as the Finals Matches and must be shot individually.
- 37.5 There will be **NO** make up bolts shot and **NO** equipment failures allowed. **Bolt holes in the target face must be marked** in case of pass throughs or bouncers.
- 37.6 In the Finals the Judges call the score and the competitor's agent checks the score, draws the bolts, **marks the bolt holes** and signs the score sheet at the completion of the match.
- 37.7 The competitor's agent is appointed by the competitor.
- 37.8 A competitor arriving after the appointed time for the start of their match will forfeit the match.

#### 37.9 Range Layout

- 37.9.1 The shooting direction is to be within +/- 20 degrees of north in the Northern Hemisphere and of south in the Southern Hemisphere.
- 37.9.2 The grounds and the location of the targets shall provide substantially equal conditions for all competitor's. All competitors shall be accommodated on the same range.
- 37.9.3 The range will be squared off and will be accurately **measured 30 metres from a point** vertically beneath the centre (gold) of each target face to the shooting line along the ground. Tolerance on the distance shall be +/- 15cm.
- 37.9.4 The targets shall be inclined backwards such that the angle from vertical is about 10 to 15 degrees with all targets appearing uniform
- 37.9.5 Provision will be made for sufficient targets to allow for not more than two competitors per target in the Eliminations and one competitor per target in the Finals.
  - 37.9.5.1 With one competitor per target the centre of the face will be 130cm (tolerance of measurement will not exceed +/- 5cm) above the ground as measured from an estimated even ground level. The face will be placed in the centre of the target butt (refer Section 6, Appendix 4). The height of the centres of the faces in a line of target butts, on the range should look straight at all times.
  - 37.9.5.2 With two competitors per target (two face setup) the centre of the faces will be 130cm (tolerance of measurement will not exceed +/- 5cm) above the ground as measured from an estimated even ground level. Each of the faces will be placed in its half of the target butt (Refer Section 6, Appendix 4) and the

minimum distance between the scoring zones of the faces will be 1cm. The height of the centres of the faces in a line of target butts, on the range should look straight at all times

- 37.9.6 Targets butts shall be spaced such that there is at least 1.5m per competitor per target butt.
- 37.9.7 A point on the shooting line directly opposite each target face will be marked and there shall be a number corresponding to that target face positioned 2m in front of the shooting line.
- 37.9.8 Shooting lanes shall be at right angles to the shooting and target lines, the width of each being sufficient to accommodate all the competitor's on each target butt in each lane which may contain one, two or three butts. Lanes shall be marked on the ground from the shooting line to the 30 metre target line.
- 37.9.9 A target line shall be marked on the ground at **the 30 metre distance**, parallel to the shooting line
- 37.9.10 A waiting line should be indicated at least five metres behind the shooting line
- 37.9.11 An equipment area shall be from the waiting line, to a line 2m behind the waiting line.
- 37.9.12 A spectator line should be indicated at least ten metres behind the waiting line,
- 37.9.13 The field should, be marked or roped-off and only competitor's taking part in the event and persons otherwise authorised shall be allowed to enter. Spectators shall be outside of the Spectator Barriers at all times.
- 37.9.14 At World Championships suitable safety blinds shall be erected at each end of the target line approx 3 metres out from and 2 metres in front of the end targets. They shall be constructed big enough and strong enough to accommodate all Judges, Scorers and runners who are required at the targets in safety and without bolt penetration.
- 37.9.15 Suitable barriers must be erected around the range to keep spectators back. These barriers will be at least 15 metres away from the ends of the target line and may, if desired, reduce in a straight line to a minimum of 5 metres away from the ends of the Shooting Line. The barriers will be at least 10 metres behind the waiting line and as far beyond the target line set at 30 metres to prevent members of the public passing closer than 65 metres behind the target butts. The safety distance of 65 metres may be reduced when an adequate backstop, e.g. efficient netting, bank or similar device, is erected (not a hedge or penetrable fence). Such a backstop must be high enough to stop bolts, which have just missed the top of the butt **at 30 metres**. Consideration should be given to any distractions caused to the competitors by movement of people, etc. behind the butts.
- 37.9.16 Traffic lights are to be placed on both sides of the field and, if necessary, in a clear lane in the centre of the target butts so that both right and left handed competitors will be able to see them. They are to be placed in front of the shooting line on each side of the field and in the clear lane at any distance shorter than 30 metres, as long as they are visible to all competitors on the shooting line.
- 37.9.17 A layout for World Outdoor Match-play Championships Tournaments is shown in *Section 6, Appendix 8*.

#### 37.10 Venue Equipment

##### 37.10.1 Targets (Buttresses)

The front of the buttress shall encompass a circle or square of at least 124 x 85cm (for two target faces) or 85 x 85cm (for one target face), this will ensure that any bolt hitting the butt and just missing the outermost edge of the scoring zone remains in the butt. The butt is to be made from suitable material such that bolts will not ordinarily rebound from, pass through or be damaged by it.

- 37.10.2 The target butt shall be supported and secured on a suitable framework so that its centre is 130 cm +/- 5 cm above the average surrounding ground level. The Butts and the framework will be secured to the ground in such a manner as to prevent them from being blown over or collapsing. Particular care must be taken when more than one target face is placed on the butt, that bolts passing through the butt are not damaged by the support. (*Refer Section 6, Appendix 4*).
- 37.10.3 The target shall be inclined backwards such that the angle from vertical is about 10 to 15 degrees with all targets appearing uniform.
- 37.10.4 A wind indicator flag shall be fitted to each target, such flags shall be of any light material and colour and shall be positioned above the centre of each butt high enough to allow a clearance of a minimum of 5cm between the bottom of the flag strips and the top of either the buttress or the target number, whichever is the higher. (*Refer Section 6, Appendix 5 for diagram of wind indicator flag*)
- 37.10.5 Target faces shall be numbered. The numbers shall be 30cm tall and shall be black figures on a yellow background, alternating with yellow figures on a black background (eg. No. 1 black on yellow, No. 2 yellow on black, etc.). Target numbers shall be affixed above the centre of each target face (*Refer Section 6, Appendix 4*).

#### 37.11 Target Faces

Refer to Clause 36.3

#### 37.12 Time Control Equipment

Refer to Clause 36.4

#### 37.13 Miscellaneous Equipment

The equipment outlined below is mandatory for WCSA Championships and is recommended for other important tournaments.

- 37.13.1 Registration numbers to be worn by each competitor.
- 37.13.2 A raised platform with seating facilities for the Director of Shooting.
- 37.13.3 Loudspeaker equipment and Equipment such as Field Telephones, "walkie-talkies" and the like which are most useful for communication between officials.
- 37.13.4 A device to indicate the order of shooting A or B, if the competitors do not all shoot at the same time. Two or more of these devices will be needed.
- 37.13.6 Sufficient chairs or benches behind the waiting line for all competitors, Team Captains, Judges and other officials.
- 37.13.7 One large scoreboard for progressive totals after each end. The large scoreboard may be supplemented by displaying the progressive scores of all competitors after each end at the target as per clause 37.13.8.
- 37.13.8 A device (Mandatory for World Championships) with the competitor's name and/ or target number 1A, 1B or simply

A, B may be used for displaying progressive total scores after each end. When this device is being used, it will be placed on the ground in front of and below each butt. It must be pegged or fixed securely to prevent movement by wind. It will be changed by the appointed Scorer, aided by the Competitors or the Competitors Agent on that target butt, after the bolts have been scored and drawn, and before they leave the target butt.

#### 37.14 Shooting Control and Safety

- 37.14.1 A Director of Shooting will be appointed. Whenever possible this will be a Judge. He/she will not participate in the shooting. Assistants may be appointed as necessary at the discretion of the Organising Committee to assist the Director of Shooting in the execution of all the duties.
- 37.14.2 The Director of Shooting will institute and enforce any reasonable safety measures he/she considers necessary
- 37.14.3 Shooting shall not commence unless safety conditions have been endorsed by the Judges and the Director of Shooting.
- 37.14.4 The Director of Shooting shall give a five (5) and two (2) minute warning before the start of competition shooting.
- 37.14.5 At the commencement of each end two (2) sound signals for the competitors to occupy the shooting line.
- 37.14.6 The signal to commence shooting shall be one (1) sound signal.
- 37.14.7 The signal to cease shooting, score and collect bolts shall be three (3) sound signals.
- 37.14.8 A series of sound signals shall indicate danger and all shooting must cease immediately on the first sound signal. The signal to resume shooting shall be one (1) sound signal.
- 37.14.9 After the start of an end all shooting shall stop on the first sound signal.
- 37.14.10 Whenever the shooting line is clear, with all competitors having finished shooting their bolts before the end of the time limit, the appropriate signal for scoring will be given immediately.
- 37.14.11 Competitors in World Championships will not go forward to score (this will be done by judges or scorers and bolts will be returned by runners).
- 37.14.12 No competitor will occupy the shooting line except when the appropriate signal has been given.
- 37.14.13 A competitor may not span or load a crossbow with a bolt, except when standing on the shooting line and under the control of the Director of Shooting. A competitor may check his/her stance/position on the shooting line, by lifting the crossbow (which is not to be spanned or loaded with a bolt) and shall only aim towards his/her target, but only after being satisfied that the field is clear both in front of and behind the targets. If a competitor, whilst checking his/her stance/position on the shooting line, before the shooting starts looses a bolt, intentionally or otherwise, will be disqualified and removed from the competition on the matter of safety.
- 37.14.14 While shooting is in progress only those competitors whose turn it is to shoot may be on the shooting line. Spotting telescopes may be left on the shooting line.
- 37.14.15 After a competitor has shot his/her bolts, he/she may retire behind the waiting line with or without his/her equipment or alternatively may wait on the shooting line for the next end of the match.
- 37.14.16 No competitor or other person may touch the tackle of another without the latter's consent.
- 37.14.17 A competitor shall not be disturbed or approached during shooting except in an emergency.
- 37.14.18 No person shall approach a target or go forward of the shooting line unless the Director of Shooting has signalled permission to do so.
- 37.14.19 Any remark or action made that may cause annoyance or confusion to a competitor or may detract from his/her concentration is un-sportsmanlike and is not allowed. The Judge(s) shall first caution the offender, and if the offence is repeated, may direct him/her to leave the competition area and go behind the spectator barrier. If it is the other competitor then they are disqualified from the competition.
- 37.14.20 In the event of a competitor not being satisfied with a ruling given by the Judges, he/she may appeal to the Jury of Appeal. Trophies or prizes which may be affected by a dispute will not be awarded until the Jury ruling has been given.
- 37.14.21 Should a target face become unreasonably worn or otherwise disfigured, or should there be any other complaint about range equipment, a competitor or his team captain may appeal to the Judges or Director of Shooting to have the defective item replaced or remedied.

#### 37.15 Order of Shooting and Timing Control

- 37.15.1 A shooting time limit shall be applied, such time limit shall be one minute for one 1 bolt or three minutes for three (3) bolts. Any bolts not shot after this time shall be lost. If any bolt is shot outside the time limit for an end, the competitor's highest scoring bolt for that end shall be forfeited
- 37.15.2 When the shooting is controlled by plates: two plates are essential in the clear lane so that the same side of the plates (all yellow or black & yellow stripes) is displayed simultaneously to all competitors. The BLACK and YELLOW striped side will be turned towards the competitors as a signal of warning that only thirty (30) seconds are left of the time limit. The YELLOW side of the plate will be turned toward the competitors at all other times.
- 37.15.3 When shooting is controlled by Lights.
- RED:** The Director of Shooting shall give two sound signals for the designated competitors to occupy the shooting line all together.
  - GREEN:** On the lights changing Green (10 seconds after the 2 sound signals) the Director of Shooting will give one sound signal for shooting to start.
  - YELLOW:** This light will go on when only 30 seconds are left of the time to shoot. In the finals matches if digital timers are used this light can be deleted. If deleted competitors are to be informed.
  - RED:** Means that the Time Limit has expired and three sound signals will be given to indicate that the shooting is to stop, even if all bolts have not been shot. Any competitor still on the shooting line, must immediately lower the crossbow, remove the bolt from the bow and the string un-spanned (unlatched and lower the string).

- 37.15.4 If digital timers are used they are to be synchronised with the lights. Should there be a discrepancy between the lights and digital timers the digital timers take precedence
- 37.15.4 When the Director of Shooting has ascertained that all competitors have completed shooting or the time limit has expired, three (3) sound signals will be given as the signal to score and return bolts to the competitors.
- 37.15.5 When all competitors are ready to shoot again the Director of Shooting shall signal the start of the next end with two (2) blasts to move to the shooting line followed by one (1) blast to commence shooting. This method shall continue until the Match is completed.
- 37.15.6 When shooting is suspended during an end for any reason, the time limit will be adjusted according to the number of bolts remaining and the period of time permitted. eg: **ninety seconds per bolt**.
- 37.15.7 In the finals Competitors shall be divided into shooting details namely A and B for each match, shooting at different times. The Elimination Matches may be shot in the same way or all shooting together in the same detail.

### 37.16 Shooting

- 37.16.1 Practice shall be made available to all competitors 30 minutes before commencement of their match on a ground alongside the competition range with the same conditions and conducted under the control of a Director of Shooting.
- 37.16.2 A bolt shall not be deemed to have been shot if;
- the competitor can touch it with his/her bow without moving his/her feet from their position in relation to the shooting line, in which case another bolt may be shot in its place.
  - the target face or buttress falls over (in spite of having been fixed and pegged down to the satisfaction of the Judges In this case, the Judges will take whatever measures they deem necessary and compensate adequate time for shooting the relevant number of bolts. If the buttress only slides down it will be left to the Judges to decide what action to take, if any.
- 37.16.3 There will be **NO time allowance for an equipment failure**. It will be up to the competitor to have their equipment in good order and/or spare equipment on immediate standby near them on the waiting line.
- 37.16.4 During the act of shooting, a competitor shall have one foot wholly behind the shooting line, or both feet on the shooting line. However, a competitor who is physically handicapped may shoot from a chair or otherwise in such a position that half of their body is behind the shooting line.

### 37.17 Scoring

- 37.17.1 The scoring zone values shall be 10, 9, 8, 7, 6, 5, 4, 3, 2, and 1 from the centre outwards with clear tens (10s) (a 10 not touching the outer 10 scoring zone line) being marked on the score sheet with a circle around it. A miss is marked as an X.
- The clear tens (10s) are used in tie breaking.
- Where partial target faces are in use, the scoring values shall be 10, 9, 8, 7 and 6 from the centre outwards with the same qualification on the clear tens (10s).
- 37.17.2 Neither the bolts nor the face shall be touched until all bolts on that target have been recorded.
- 37.17.3 A bolt shall be scored according to the position of the shaft in the target face.
- 37.17.4 **All bolt holes on the target face will be marked to allow for the scoring of bouncers and pass throughs. This will be done by the Competitor's Agent after the scoring of each end.**
- 37.17.5 Any competitor's agent shall refer any questions about the value of an bolt in the target to a Judge before the bolts are drawn.
- 37.17.6 A mistake on a score sheet discovered before the bolts are drawn may be corrected, but the correction must be made and initialled in red by a Judge before the bolts are drawn . If the bolts have been drawn, no corrections to the bolt values as written on the score sheet shall be permitted. Any other disputes concerning entries on a score sheet shall be referred to a Judge.
- 37.17.7 Should the shaft of a bolt touch two colours, or touch any dividing line between scoring zones, that bolt shall score the higher value of the zones affected.
- Should a fragment of a target face be missing which includes a dividing line or where two colours meet or if the dividing line is displaced by a bolt, then an imaginary line shall be used for judging the value of any bolt that may hit such a part.
- 37.17.8 If more than three bolts belonging to the same competitor should be found in the target or on the ground in the shooting lanes either in front of or behind the target, only the three lowest in value shall be scored.
- Should a competitor be found to repeat this, he/she may be disqualified.
- 37.17.9 A bolt hitting:
- the target and rebounding, the competitor concerned shall complete the shooting of that end of (2) three bolts, and shall take one step back (approx 0.5m) from the Shooting Line with his/her free hand held aloft holding the signal flag as a signal to a judge, who shall then inform the judges in the blinds.
  - a bolt which may have passed through the target or rebounded from it (which may not have struck a bolt) is found lying on the ground (when going to score) behind or in front of the target, it shall not be picked up before the Judge(s) have seen it, who being satisfied that the bolt has passed through the target or rebounded from it and not from striking another bolt. In such a case they shall allow the score of the unmarked bolt hole.
  - another bolt remaining embedded therein, shall score according to the value of the bolt struck.
  - another bolt, and then hitting the target face after deflection, shall score as it lies in the target face,
  - another bolt, and then rebounding from the target, shall score the value of the struck bolt, provided the damaged bolt can be identified.
  - a target face other than a competitor's own target face shall not score.

- 37.17.10 Competitors shall appoint an agent to act on their behalf at the targets, to pull their bolts and give them to the runners for return to the competitor during the scoring of the following end.
- 37.17.11 Scorers shall enter on score sheets and in descending order the value of each bolt as called out by the judge. The competitor's agent shall check the value of each bolt called out. Only bolts scoring ten points shall be referred to as "Golds".
- 37.17.12 On completion of a Match, score sheets shall be signed by the competitor's agent, denoting that the competitor's agent agrees with the value of each bolt.
- 37.17.13 An incorrectly totalled score sheet shall be corrected.
- 37.17.14 A scoring board or some such device with the competitors' names and/or target numbers is permitted for displaying progressive and/or total scores after each end.

### 37.18 Ties

In the event of a tie in score in a match, the tie will be broken as follows:

A shoot off will take place between the two (2) competitors one bolt at a time for three ends (3). The competitor with the first highest scoring bolt is declared the winner. If at the end of 3 ends it is still tied then the bolt on the third end closest to the centre of the target is declared the winner.

### 37.19 Questions, Disputes and Appeals

- 37.19.1 Questions concerning the conduct of the shooting or the conduct of a competitor must be lodged with the Judges before the next round of matches start.
- 37.19.2 Appeals against rulings by the Judges, Director of Shooting or Tournament Officials must be presented in writing to the Jury of Appeal before the competitors next match. No appeals can be made against the value of a bolt.
- 37.19.3 Appeals against the conduct of the shooting or the conduct of a competitor shall be lodged in writing with the Judges or Jury of Appeal before the competitors next match.
- 37.19.4 Queries/Questions regarding daily published results shall be lodged with the Tournament Committee without any undue delay, and in any event must be lodged in time to allow corrections to be made prior to any prize giving.
- 37.19.5 When the awarding of trophies or prizes may be affected by an appeal or appeals, they shall not be awarded until the Jury ruling has been given.
- 37.19.6 Should a target face become unreasonably worn or otherwise disfigured, or should there be any other complaint about range equipment, a competitor, his/her agent or team captain may appeal to the Judges or Director of Shooting to have the defective item replaced or remedied.
- 37.19.7 A competitor's agent shall refer any questions about the value of a bolt in the target to a Judge before the bolts are drawn. Should any competitor's agent be dissatisfied with the Judge's ruling, the majority decision of that Judge and no more than the two nearest available shall be final.
- 37.19.8 A mistake on a score sheet discovered before the bolts are drawn may be corrected, but the correction must be made and initialled by one of the Judges before the bolts are drawn. If the bolts have been drawn, no corrections to the bolt values as written on the score sheet shall be permitted.

### 37.20 Jury of Appeal

*For World Championships refer to Section 1, clause 20.*

- 37.20.1 A Jury of Appeal of three members shall be appointed by the Organising Committee. Persons participating in the Championships are not eligible for the Jury of Appeal. Members of the Jury of Appeal shall preferably be persons with experience and a good knowledge of the sport and rules. Where a Jury of Appeal has not been appointed, the Organising Committee shall assume this role.
- 37.20.2 Appeals must be presented, in writing, by Team Managers, or appellants if no Team Manager has been designated or they are individual member competitors. No appeal can be made against the value of a bolt. An intention to appeal when it might affect the progression of a competitor from one stage of the competition to the next must be expressed in writing and lodged with the chairperson of the Tournament Judge Commission within 5 minutes of the end of the match. The written appeal must be lodged with the Jury in time to allow the Jury to come to a decision before the beginning of the next stage of the competition.
- 37.20.3 The Jury must be available at the Tournament grounds at all times during the Tournament or event (including the day of official practice) until thirty minutes after the end of shooting.
- 37.20.4 Jury decisions shall be minuted and submitted to the appellant, the Chairperson of the Tournament Judge Commission and the Organising Committee before the beginning of the next stage of the competition or before the awarding of prizes. The ruling of the Jury of Appeal shall be final.
- 37.20.5 **Protest Fee**  
All appeals must be submitted in writing not later than one hour after the close of the days shooting and before any prize giving and be accompanied by a fee if one is applied by the Organising Committee (for World Championships Refer to Book 1, clause 20). The fee applied shall be returned if the appeal is upheld and shall be retained by the Organising Committee if the appeal is lost.
- 37.20.6 Decisions made by the Jury of Appeal must be documented and submitted to the appellant, the Chairman of the Judges Commission and the Chairperson of the Organising Committee before the awarding, of prizes or the next stage of the competition as the case may be. This terminates the path of appeal.

### 37.21 Director of Shooting

- 37.21.1 A Director of Shooting and a Deputy will be appointed.
- Whenever possible they will be Judge's. They will not participate in the shooting or have other tasks during the hours of the shooting.
  - Assistants may be appointed as necessary at the discretion of the Organisers to assist the Director of Shooting and the Deputy in the execution of all their duties.
- 37.21.2 The Director of Shooting will institute and enforce any reasonable safety measures he/she considers necessary (see also) his/her duties include,
- Controlling the shooting, regulating the timing of ends, and the order in which the competitors will occupy the shooting line

- b) Exercising control over the use of the loudspeaker equipment, the activities of photographers, etc., so that competitors are not disturbed,
- c) Ensuring that spectators remain behind the barriers enclosing the shooting range.
- d) In the case of an emergency giving a series of not less than five sound signals for all shooting to cease. If shooting is suspended during an end for any reason, one sound signal will be given for shooting to re-continue;

### 37.22 Judges

37.22.1 The Judges' duties are to ensure that the Match-play is conducted according to the World Crossbow Shooting Association Constitution & Rules, and in fairness to all competitors.

37.22.2. There must always be a minimum of three judges. Their duties will be as follows:

They will:

- a) check all distances and the correct layout of the range;
- b) check the dimensions of target faces and target butts;
- c) check that the faces are set at the correct height from the ground;
- d) check that all butts are set at a uniform angle.
- e) check all the necessary venue equipment;
- f) check all the medal winning competitors' equipment immediately after the completion of the competitors medal winning match.
- g) control the conduct of the shooting;
- h) **call the scores** and control the conduct of the scoring;
- i) call and verify the scoring in the Finals Rounds;
- j) consult with the Director of Shooting on questions, which arise regarding the shooting;
- k) handle any disputes and appeals which may arise and, where appropriate, pass them on to the Jury of Appeal;
- l) in liaison with the Director of Shooting, interrupt the shooting if necessary.
- m) consider relevant complaints or requests from competitors and Team Captains and where applicable to take suitable action. Collective decisions will be made by a simple majority of votes. In case of a tie, the Chairman will have a tie breaking vote;
- n) deal with questions concerning the conduct of the shooting or the conduct of a competitor. These questions must be lodged with the Judges without any undue delay and in any event must be lodged before the prize giving. The ruling of the Judges or Jury of Appeal, as applicable, will be final.
- o) ensure that all competitors and officials conform with the World Crossbow Shooting Association Constitution and Rules as well as decisions and directives the Judges may find necessary to make. A competitor proved to have transgressed any rules and regulations knowingly may be ruled to be not eligible to participate and be eliminated and will lose any position he or she may have gained.

## SCHEDULE 1 - OUTDOOR TARGET ROUNDS:

Number of bolts at each distance

Round	Total Bolts	Distances in metres									Possible score
		70	65	60	55	50	45	40	30	20	
<b>MC 600 (World Champs)</b>	<b>60</b>							<b>20*</b>	<b>20*</b>	<b>20*</b>	<b>600</b>
<b>MISCELLANEOUS ROUNDS</b>											
TC 900	90		30*		30*		30*				900
Pacific	90			30*		30*		30*			900
Atlantic	60						30*		30+		600
Mediterranean	30		30*								300
Baltic	30				30+						300
Great Southern	30						30+				300
TC 960	96	24*		24*		24*		24*			960
XBow FITA Women	144	36*		36*		36+			36+		1440
Match-play (per match)	6						6*				60

Legend: \* 60cm Multi coloured target face  
+ 40cm Multi coloured target face

The SC 600 and the Match-play are the only rounds which can be shot for world records or World Crossbow Shooting Association Stars. The other rounds are listed to give a variation of shoots, which members may shoot if they want to shoot something different.

# **SECTION FOUR**

## **Forest Round**



## 38 THE RANGE

### 38.1 Course Layout

- 38.1.1 WCSA Forest courses shall be laid out so that the shooting pegs and targets can be reached without undue difficulty, personal hazard or waste of time. Targets shall be laid out in such order as to provide a maximum variety and the best use of the available terrain.
- 38.1.2 WCSA sanctioned Medieval Crossbow events shall be conducted using 2-zone paper animal faces.
- 38.1.3 Two (2) pegs shall be placed approximately one (1) metre apart at each target shooting distance so that two competitors may shoot together, one from either side.
- 38.1.4 All pegs must be numbered with the number of the corresponding target and the distance when Marked distances are to be shot.
- 38.1.5 Group 4 faces shall be arranged in four vertical columns each of three faces.
- 38.1.6 Group 3 faces shall be placed four (4) per buttress in the form of a square.
- 38.1.7 Distance tolerance from peg to target shall not exceed +/- 25 cm on distances of 20 metres or less, and shall not exceed +/- 50 cm on distances greater than 20 metres. All distances shall be measured in the air.
- 38.1.8 The buttresses shall provide for a margin of at least 5 cm outside the lowest scoring zone (s) placed upon it. At no point may any target face be less than 15 cm above the ground. In all cases, regardless of the slope of the terrain, the buttress should be located reasonably vertical, and none of the face shall be obscured from the shooters' line of sight.
- 38.1.9 All targets shall be numbered successively. The numbers shall be no less than 20 cm tall and shall be yellow on black or black on yellow and shall be located within the approach to the pegs for the targets. They shall also serve as a holding point for those competitors waiting to shoot.
- 38.1.10 Faces shall not be placed over any larger face, nor shall there be any marks on the buttress or foreground that could be used as points of aim.
- 38.1.11 Clearly visible direction signs indicating the route from one target to the next target must be located at strategic intervals to ensure safe and easy communication along the course.
- 38.1.12 Suitable barriers and signs shall be placed around the course, when necessary to keep spectators and non-competitors at a safe distance, without unnecessarily obstructing their view of the shooting.
- 38.1.13 Only those people with the appropriate accreditation shall be allowed on the course. Team Managers and other officials are not allowed on the course.
- 38.1.14 Championship courses should be newly laid-out and un-shot.
- 38.1.15 Courses must be ready for inspection by the Judges' Commission no later than two (2) days before the competition shooting is due to commence.
- 38.1.17 Course laying:
  - 38.1.17.1 Because WCSA Forest Round courses use natural terrain with trees and shrubs in the course layout, it is usually only the immediate vicinity which is in view. Therefore maximum safety precautions must be taken, both in the layout and in the shooting.
  - 38.1.17.2 Consider the path to and from the shooting pegs and targets and clearly mark them. Ensure that possible lines of bolt flight will not endanger competitors.
  - 38.1.17.3 Where possible, do not allow any path or another shooting stand to be visible from any other shooting stand, even if it is considered out of range.
  - 38.1.17.4 Consider the spectators when positioning buttresses. Targets must not be placed where a stray bolt could endanger the public.
  - 38.1.17.5 Targets should never be placed on the brow of a hill, where the landing of overshoots cannot be determined.
  - 38.1.17.6 When laying out the course, ensure that safe flight path is available for both left and right handed shooters, for light and heavy bows and for short and tall arbalists.
  - 38.1.17.7 Course laying is an acquired skill. Organisers are advised to enlist the services of an experienced Field Archery course layer when setting out a course for the first time.

### 38.2 Miscellaneous Equipment

The equipment outlined below is mandatory for WCSA Championships and is recommended for other important tournaments.

- 38.2.1 Registration numbers to be worn by each competitor.
- 38.2.2 Equipment such as Field Telephones, two way radios and the like are necessary for communication between officials.
- 38.2.3 A score board or some other such device with the competitor's name and/ or target number 1A, 1B may be used for displaying progressive total scores after each day.

### 38.3 Shooting Control and Safety

- 38.3.1 A competitor may not span or load a crossbow with a bolt, except when standing at the shooting peg.
- 38.3.2 While shooting is in progress only those competitors whose turn it is to shoot may be at the shooting peg. All other competitors shall remain at the holding position (Target number) with their equipment.
- 38.3.3 After a competitor has shot his/her bolts, he/she shall retire to the holding position (Target number) with his/her equipment.
- 38.3.4 No competitor or other person may touch the tackle of another without the latter's consent.
- 38.3.5 A competitor shall not be disturbed or approached during shooting except in an emergency.
- 38.3.6 No competitor shall approach a target or go forward of the shooting peg unless all the competitors in the group have finished shooting the required number of bolts for that target.

- 38.3.7 To ensure the proper conduct of a tournament and in the interests of safety, the Judges may request a competitor to change his/her shooting position on the line or join another target group. If the competitor considers the Judges' request to be unreasonable his/her appeal to the Jury of Appeal shall be heard prior to any change in position.
- 38.3.8 Any remark or action made that may cause annoyance or confusion to a competitor or may detract from his/her concentration is un-sportsmanlike and is not allowed. The Judge(s) shall first caution the offender, and if the offence is repeated, may direct him/her to withdraw from the event.
- 38.3.9 In the event of a competitor not being satisfied with a ruling given by the Judges, he or she may, except as provided for in rule 38.9.1 below, appeal to the Jury of Appeal according to rule 38.9. Trophies or prizes which may be affected by a dispute will not be awarded until the Jury ruling has been given.
- 38.3.10 Should a target face become unreasonably worn or otherwise disfigured, or should there be any other complaint about range equipment, A competitor or his/her Team Manager may appeal to the Judges to have the defective item replaced or remedied.

#### 38.4 Order of Shooting and Timing Control

- 38.4.1 Competitors shall shoot in groups of no more than four (4), but never less than three (3). Should the number of competitors exceed the course capacity, additional groups shall be formed and placed on the course as convenient. Groups shall be assigned by drawing competitor names from a container, provided that there are no more than two competitors from one country in the same group. The group assignment shall be made by the Chairperson of the Organising Committee.
- 38.4.2 Competitors shall wear registration numbers and be allocated targets and shooting positions indicating the order of shooting in each group. Shooters shall be designated 1A, 1B, 1C, 1D, 2A, 2B, 2C, 2D, etc.
- 38.4.3 Each group shall shoot in details, rotating as follows:
- 38.4.3.1 For a four person group, two competitors shall shoot at the peg, one on either side, rotating: first target AB-CD, the next target CD-AB then alternating for the remainder of the course.
- 38.4.3.2 For a three person group, the order shall be: AB-C, C-AB, AB-C, etc.
- 38.4.4 The shooting position shall be with both feet behind an imaginary straight line parallel to the target face, with one of the archer's feet within 30cm of the post. The imaginary line shall be 1 metre in length each side of the post and be parallel to the target face.
- 38.4.5 Competitors shall shoot two (2)-bolts at each target in ascending order. **Both bolts will be scored according to clause 38.7.8.**
- 38.4.6 Shooting at Group 4 faces:  
For the first detail the competitor on the left shall shoot at the top left hand face and the competitor on the right shall shoot at the top right hand face. For the second detail, the competitor on the left shall shoot at the bottom left hand face and the competitor on the right shall shoot at the bottom right hand face.
- 38.4.7 Shooting at Group 3 faces:  
The competitors on the left will shoot at the face on the left and the competitors on the right will shoot at the face on the right.
- 38.4.8 Competitors will shoot only one shot from each peg either in a walk-up or fan format.  
**Walk-up shots** have 2 pegs at different distances and one bolt is shot from each peg starting at the peg farthest away from the target with the lowest numbered bolt and moving forward to the next peg for the second shot.  
**Fan shots** have 2 pegs set at the same distance but spaced out sideways starting with the competitors making the first shot from the left peg with the lowest numbered bolt and then moving to the right to the next peg for the second shot.
- 38.4.9 Groups shall be assigned to start simultaneously from various targets and will complete the round at the target previous to one at which they started. Additional groups assigned to a target shall wait until the primary group on that target has shot and scored their bolts before proceeding. Groups shall be spaced out so as to avoid "bunching". Where there are more groups than target starting positions, the extra groups shall be queued on the last target and started by a Judge.
- 38.4.10 In the case of equipment failure, the order of shooting may be changed temporarily. In any event no more than thirty (30) minutes shall be allowed to repair any problem. The other competitors in the group shall shoot and score their bolts before allowing any following groups to shoot through. If the repair is completed within the time limit, the competitor affected may make up any bolts remaining to be shot at that target.
- 38.4.11 Competitors in a group may allow other groups to "shoot through", provided that the Organisers or the Judges are notified.
- 38.4.12 A time limit of five (5) minutes for **2 bolts** per target per competitor shall be allowed from the time the competitor takes his or her position at the first peg, which he or she shall do as soon as it becomes available. Judges are required to time a competitor or a group who are causing undue delay in the competition. A Judge, having observed a competitor exceeding the time limit, shall caution him or her by a signed note on the scoresheet, indicating the time of the warning. For a second or subsequent warning during that stage of the competition, the competitor's highest scoring bolt at the target shall be forfeited.  
The time limit may be extended in exceptional circumstances.
- 38.4.13 Time warnings shall not be carried over from one stage of the competition to the next.

#### 38.5 Target Faces and Distances

- 38.5.1 For the Marked and Unmarked WCSA Forest Round animal faces with two (2) scoring zones shall be used.
- 38.5.2 The faces consist of pictures (photographs/drawings/painting) of animals and shall be in such colours and contrast that people with normal eyesight can see them clearly under normal daylight conditions at the relevant distances in the various target settings. The pictures should be printed with a non-reflective medium on white background. Coloured picture faces must be used in the World Championships.
- 38.5.3 The faces shall have an inner ring and an outer body (hair) line.
- 38.5.4 The inner ring (heart/lung area being oval in shape) shall score twenty (20) points.

- 38.5.4 The outer (hair) line must closely follow the body contour or if there is no line the outline of the animal shall constitute this line. This shall score ten (10) points. Anything outside of the outer (hair) line is non scoring.
- 38.5.5 To score the bolt must be inside and not touching the line marking the scoring zone.
- 38.5.6 Bolt score values:-  
 1st bolt = full value of the scoring zone hit.  
 2nd bolt = half the value of the scoring zone hit.
- 38.5.7 There will be:-  
 a) 4 Group 4 faces fixed on the butt in the form of a square (1 for each competitor).  
 b) 2 Group 3 faces fixed on a butt side by side (1 for each 2 competitors).  
 c) Groups 1 & 2 only have 1 face fixed per butt (used by all competitors).

Target Face groups and sizes:

Target sizes (approximately)	Inner ring size
Group One 710mm (28 inches) x 1020mm (40 inches)	228mm (9 inches) x 368mm (14.5 inches)
Group Two 570mm (22.5 inches) x 725mm (28.5 inches)	177mm (7 inches) x 267mm (10.5 inches)
Group Three 360mm (14.25 inches) x 570mm (22.5 inches)	115mm (4.5 inches) x 177mm (7 inches)
Group Four 285mm (11.25 inches) x 360mm (14.25 inches)	64mm (2.5 inches) x 92mm (3.625 inches)

#### Target group and distance variation:

This table indicates the number of targets at each group size and the distance variations allowed for the course per 12 target unit. Double this for the WCSA Forest Round. The spacing between targets is not specified, but must be such as to maintain safety.

Number of targets	Face diameter	Distance variation - metres
2	Group 4	8 to 15
2	Group 3	10 to 25
4	Group 2	20 to 35
4	Group 1	30 to 45

## 38.6 Shooting

- 38.6.1 Practice facilities shall be made available to all competitors at the ground before commencement of the event and conducted under safety control.
- 38.6.2 When a round is shot over several days there shall be practice facilities available at the commencement of each day.
- 38.6.3 A bolt shall not be deemed to have been shot if  
 a) the competitor can touch it, or would be able to touch it if the ground was reasonably level ,with his/her bow without moving his/her feet from their position in relation to the shooting peg, in which case another bolt may be shot in its place. If another bolt is not available the competitor may retrieve his/her bolt with the Judges' permission.  
 b) the target face or buttress falls over. In this case, the Judges will take whatever measures they deem necessary and compensate adequate time for shooting the relevant number of bolts. If the buttress only slides down it will be left to the Judges to decide what action to take, if any.
- 38.6.4 Under no other circumstances shall a bolt be re-shot.
- 38.6.5 Shooters shall not discuss with one another the distances on unmarked courses.
- 38.6.7 In the event of equipment failure the competitor shall step back off the shooting line (approx 0.5m) and call a Judge. The competitor will be allowed to shoot any make up bolts on that target after the equipment has been repaired/replaced before moving to the next target.
- 38.6.8 A broken crossbow may be replaced with a spare, provided that it has been passed for equipment inspection. In such cases a Judge shall supervise the replacement or escort the shooter off the course, whichever is quicker.
- 38.6.9 Except as provided in clause 38.6.8, no shooter shall leave the course until they have finished the round. Shooters shall take all necessary food, drinks and spare equipment with them.
- 38.6.10 In the event of a competitor being unable to continue shooting because of an unexpected medical problem which occurs after the beginning of the shoot, no more than 30 minutes will be allowed for medical personnel to determine the problem and decide whether or not the competitor is fit to continue competing unassisted.
- 38.6.11 Should a group be held up due to an equipment failure or medical problem they will complete that target, move to one side and allow other groups to pass until the problem has been rectified.
- 38.6.12 During the act of shooting, a competitor shall be wholly behind the shooting peg.

## 38.7 Scoring

- 38.7.1 Two competitors from each group shall be designated as scorers. These will normally be those shooters designated A and B, and the score-sheets will be marked accordingly. Double scoring shall be used.
- 38.7.2 Scoring shall take place after all competitors in the group have shot their bolts.
- 38.7.3 Scorers shall enter on the score-sheet alongside the correct number of the target and in descending order the value

- of each bolt as called out by the competitor to whom the bolts belong. Other competitors in the group shall check the value of each bolt called.
- 38.7.4 Scorers shall compare their scores before the bolts are drawn. A mistake on the score-sheet discovered before the bolts are drawn, may be corrected (refer clause 38.9.2).
- 38.7.5 Neither the bolts nor the target face shall be touched until all bolts on that target have been recorded and scores checked.
- 38.7.6 A bolt shall be scored according to the position of the shaft on the face. Bolts shot in the wrong target shall not score. For a bolt to score the shaft must be completely inside the line marking the scoring zone. It must not touch the line.
- 38.7.7 To score the bolt must be inside and not touching the line marking the scoring zone.
- 38.7.8 Bolt score values:-  
     1st bolt = full value of scoring zone  
     2nd bolt = half value of scoring zone
- 38.7.9 Should a fragment of the target face be missing, including the dividing line or if the dividing line is displaced by a bolt, then an imaginary continuation of the line shall be used for judging the value any bolt which may hit that part.
- 38.7.10 Bolts imbedded in the buttress and not showing on the face may only be scored by a Judge.
- 38.7.11 Unless the bolt holes are suitably marked on each occasion when bolts are drawn from the target, bolts rebounding from or passing completely through the buttress shall not be scored except as follows:
- 38.7.11.1 If all the competitors in the group agree on the value of the bolt that has rebounded from or passed through, that bolt shall be scored as the agreed value.
- 38.7.11.2 If all the competitors in the group agree that a bolt has rebounded or passed through, but cannot agree on its value, then that bolt shall be given the value of the lowest unmarked bolt hole that can be found on the target face concerned.
- 38.7.11.3 If all the competitors in that group cannot agree that the bolt has rebounded from or passed through, then that bolt shall not be scored and a Judge may be called.
- 38.7.12 A bolt hitting:
- 38.7.12.1 Another bolt and remaining imbedded therein, shall score according to the value of the struck bolt.
- 38.7.12.2 Another bolt, and then hitting the target face after deflection, shall score as it lies in the target.
- 38.7.12.3 Another bolt, and then rebounding, shall score the value of the struck bolt, provided that the damaged bolt can be identified.
- 38.7.10.4 A target other than the competitor's own target face, shall not score.
- 38.7.13 **Score Validation:** At the completion of the course, score-sheets shall be signed by the scorers and the competitor, denoting that the competitor agrees with the values of each bolt. If the scorer is participating in the shooting, his/her score sheet shall be signed by another competitor in the same group. Competitors are responsible for the verification of their own score-sheets. Score-sheets shall be legible and complete. Duplicates shall not be issued for any lost, damaged or stolen score-sheets. Once the score-sheets have been handed in, they will not subsequently be changed. Any disagreement in scoring values between the score-sheets shall be recorded at the lower value.
- 38.7.14 Any shooter who alters or knowingly falsifies a score-sheet without authorisation shall be disqualified

## 38.8 Ties

- 38.8.1 In the event of a tie in score, the results shall be determined in the following order:
- 38.8.1.1 **For individuals:**
- The competitor, of those tying, with the greatest number of scoring hits.
  - If this is also a tie, then the competitor of those so tying with the greatest number of hits scoring twenty (20) points.
  - If this is also a tie, then the competitors so tying shall be declared equal.
- 38.8.1.2 **For Teams:**
- The team, of those tying, having the competitor making the highest individual score.
  - If this is also a tie, then the team of those so tying having the competitor making the second highest individual score.
  - If this is also a tie, then the teams so tying shall be declared equal.

## 38.9 Questions, Disputes and Appeals

- 38.9.1 Any competitor may refer any questions about the value of a bolt in the target to a Judge before any bolts are drawn. The ruling of that Judge shall be final.
- 38.9.2 A mistake on a score-sheet may be corrected before the bolts are drawn, provided that all competitors on the target agree on the correction. The correction shall be witnessed and initialled by all the competitors on the target. Any other disputes concerning entries on a score-sheet shall be referred to a Judge.
- 38.9.3 Should it be discovered that:
- the size of a target face has been changed during the competition, or,
  - the position of a shooting post has been moved after shooters have already shot the target, or,
  - the target is or has become un-shootable for certain arbalists because of hanging branches, or other obstructions,
- that target shall be eliminated for the purpose of scoring for all competitors of the division involved, should an appeal be upheld. If one or more target(s) is disqualified, the remaining targets will be considered to constitute a full Round.

- 38.9.4 Should a target face become unreasonably worn or otherwise disfigured or should there be any other complaint about course equipment, a competitor or his Team Manager may appeal to the Judges' Commission before the next stage of the competition.
- 38.9.5 Questions concerning the conduct of the shooting or the conduct of a competitor shall be lodged with the Judges before the next stage of the competition.
- 38.9.6 Questions regarding daily published results shall be lodged without undue delay, and in any event must be lodged in time to allow corrections to be made before the prize giving.
- 38.9.7 In the event of a competitor not being satisfied with a ruling given by the Judges, he or she may, except as provided for in clause 38.9.1 above, appeal through his or her Team Manager to the Jury of Appeal, in writing, before the beginning of the next stage of the competition. Trophies or prizes which may be affected by a dispute shall not be awarded until after the Jury has ruled on the dispute.

### 38.10 Jury of Appeal

*For World Championships refer to Section 1, clause 20,*

- 38.10.1 A Jury of Appeal of three members shall be appointed by the Organising Committee. Persons participating in the Championships are not eligible for the Jury of Appeal. Members of the Jury of Appeal shall preferably be persons with experience and a good knowledge of the sport and rules. Where a Jury of Appeal has not been appointed, the Organising Committee shall assume this role.
- 38.10.2 Appeals must be presented, in writing, by Team Managers, or appellants if no Team Manager has been designated or they are individual member competitors. No appeal can be made against the value of a bolt. An intention to appeal when it might affect the progression of a competitor from one stage of the competition to the next must be expressed in writing and lodged with the chairperson of the Tournament Judge Commission within **15** minutes of the end of that stage. The written appeal must be lodged with the Jury in time to allow the Jury to come to a decision before the beginning of the next stage of the competition.
- 38.10.3 The Jury must be available at the Tournament grounds at all times during the Tournament or event (including the day of official practice) until thirty minutes after the end of shooting.
- 38.10.4 Jury decisions shall be minuted and submitted to the appellant, the Chairperson of the Tournament Judge Commission and the Organising Committee before the beginning of the next stage of the competition or before the awarding of prizes. The ruling of the Jury of Appeal shall be final.
- 38.10.5 **Protest Fee**  
All appeals must be submitted in writing not later than one hour after the close of the days shooting unless it affects the next stage of a competition (see 38.10.2) and before any prize giving and be accompanied by a fee if one is applied by the Organising Committee (*for World Championships Refer to Section 1, clause 20*). The fee applied shall be returned if the appeal is upheld and shall be retained by the Organising Committee if the appeal is lost.
- 38.10.6 Decisions made by the Jury of Appeal must be documented and submitted to the appellant, the Chairman of the Judges Commission and the Chairperson of the Organising Committee before the awarding, of prizes or the next stage of the competition as the case may be. This terminates the path of appeal.

### 38.11 Course Director

- 38.11.1 The Chairman of the Judges Commission will be in overall command of the Forest Round Course on the days of the competition.  
The responsibilities are.
- a) To ensure the Safety for both competitors and spectators
  - b) To organise getting competitors to their starting target as allocated by the Organising Committee
  - c) To organise and control the Judges Commission
  - d) To start the shooting
  - e) To address the competitors on any necessary items before they go on the course.

### 38.12 Judges

- 38.12.1 The Judges' duties are to ensure that the tournament is conducted according to the World Crossbow Shooting Association Constitution & Rules, and in fairness to all competitors.
- 38.12.2 Where possible at least one Judge for every 6 target butts in the Forest Round will be appointed. However there must always be a minimum of three judges. Their duties will be as follows:
- 38.12.2.1 They will;
- a) check all distances and the correct layout of the course;
  - b) check the dimensions of target faces and target butts;
  - c) check that the faces are set at the correct height from the ground,.
  - d) check that all butts are set at the correct angle.
  - e) check all the necessary venue equipment;
  - f) check all competitors' equipment before the Tournament (time to be stated on the tournament program) and at any time thereafter during the Tournament,
  - g) control the conduct of the shooting;
  - j) to handle any disputes and appeals which may arise and, where appropriate, pass them on to the Jury of Appeal;
  - k) in liaison with the Organising Committee, interrupt the shooting if necessary, because of weather conditions, a serious accident, or other occurrences, but to ensure if at all possible, that each day's program is completed on that day,
  - l) consider relevant complaints or requests from Team Managers and where applicable to take suitable action. Collective decisions will be made by a simple majority of votes. In case of a tie,

- the Chairman will have a tie-breaking vote;
- m) deal with questions concerning the conduct of the shooting or the conduct of a competitor. These questions must be lodged with the Judges without any undue delay and in any event must be lodged before the prize giving. The ruling of the Judges or Jury of Appeal, as applicable, will be final.
  - n) make sure that at no time will any equipment failure delay the tournament by more **than 30 minutes**.
  - o) control that all competitors and officials conform with the World Crossbow Shooting Association Constitution and Rules as well as decisions and directives the Judges may find necessary to make. A competitor proved to have transgressed any rules and regulations knowingly may be ruled to be not eligible to participate and be eliminated and will lose any position he/she may have gained.

# **SECTION FIVE**

## **3D Round**

## 39 THE RANGE

### 39.1 Course Layout

- 39.1.1 WCSA 3D courses shall be laid out so that the shooting pegs and targets can be reached without undue difficulty, personal hazard or waste of time. Targets shall be laid out in such order as to provide a maximum variety and the best use of the available terrain.
- 39.1.2 WCSA sanctioned Medieval Crossbow events shall be conducted using 3D Animal Targets.
- 39.1.3 The WCSA 3D Round shall consist of 24 targets set at UNMARKED distances from a minimum of 5m up to a maximum of 45m. Refer to clause 39.5 for groups and distances.
- 39.1.4 There shall be one peg placed at each shooting distance from the target. Each competitor will shoot one bolt only, one competitor at a time.
- 39.1.5 All pegs must be numbered with the number of the corresponding target.
- 39.1.6 All distances shall be measured in the air.
- 39.1.7 All targets will be numbered successively. The numbers shall be no less than 20 cm tall and shall be clearly visible and shall be located within the approach to the pegs for the targets. They shall also serve as a holding point for those competitors waiting to shoot.
- 39.1.8 There cannot be any special marks on the buttress or foreground that could be classified as points of aim.
- 39.1.9 Clearly visible direction signs indicating the route from one target to the next target must be located at strategic intervals to ensure safe and easy communication along the course.
- 39.1.10 Suitable barriers and signs shall be placed around the course, when and where necessary to keep spectators and non-competitors at a safe distance, without unnecessarily obstructing their view of the shooting.
- 39.1.11 Only those people with the appropriate accreditation shall be allowed on the course. Team Managers and other Team Officials are not permitted on the course unless at the request of and escorted by a Judge.
- 39.1.12 Championship courses should be newly laid-out and un-shot.
- 39.1.13 Courses must be ready for inspection by the Judges' Commission no later than two (2) days before the competition shooting is due to commence.
- 39.1.14 Course laying:
  - 39.1.14.1 Because WCSA 3D Round courses use natural terrain with trees and shrubs in the course layout, it is usually only the immediate vicinity which is in view. Therefore maximum safety precautions must be taken, both in the layout and in the shooting.
  - 39.1.14.2 Consider the path to and from the shooting pegs and targets and clearly mark them. Ensure that possible lines of bolt flight will not endanger competitors.
  - 39.1.14.3 Where possible, do not allow any path or another shooting stand to be visible from any other shooting stand, even if it is considered out of range.
  - 39.1.14.4 Consider the spectators when positioning buttresses. Targets must not be placed where a stray bolt could endanger the public.
  - 39.1.14.5 Targets should never be placed on the brow of a hill, where the landing of overshoots cannot be determined.
  - 39.1.14.6 When laying out the course, ensure that safe flight path is available for both left and right handed shooters, for light and heavy bows and for short and tall archers.
  - 39.1.14.7 Course laying is an acquired skill. Organisers are advised to enlist the services of an experienced Field/3D Archery course layer when setting out a course for the first time.

### 39.2 Miscellaneous Equipment

The equipment outlined below is mandatory for WCSA Championships and is recommended for other important tournaments.

- 39.2.1 Registration numbers to be worn by each competitor.
- 39.2.2 Equipment such as Field Telephones, two way radios and the like which are necessary for communication between officials.
- 39.2.3 A score board or some other such device with the competitor's name and/ or target number (e.g. 1A, 1B) to be used for displaying progressive total scores after each day.

### 39.3 Shooting Control and Safety

- 39.3.1 A competitor may not span or load a crossbow with a bolt, except when standing at the shooting peg.
- 39.3.2 While shooting is in progress only the competitor whose turn it is to shoot may be at the shooting peg. All other competitors shall remain at the holding position (Target number) with their equipment.
- 39.3.3 After a competitor has shot his/her bolts, he/she shall retire to the holding position (Target number) with his/her equipment.
- 39.3.4 No competitor or other person may touch the tackle of another without the owner/users consent.
- 39.3.5 A competitor shall not be disturbed or approached during shooting except in an emergency.
- 39.3.6 No competitor shall approach a target or go forward of the shooting peg unless all the competitors in the group have finished shooting the required number of bolts for that target.
- 39.3.7 To ensure the proper conduct of a tournament and in the interests of safety, the Judges may request a competitor to change his/her shooting position or join another target group. If the competitor considers the Judges' request to be unreasonable his/her appeal to the Jury of Appeal shall be heard prior to any change in position.
- 39.3.8 Any remark or action made that may cause annoyance or confusion to a competitor or may detract from his/her concentration is un-sportsmanlike and is not allowed. The Judge(s) shall first caution the offender, and if the offence is repeated, may direct him/her to withdraw from the event.



- 39.3.9 In the event of a competitor not being satisfied with a ruling given by the Judges, he or she may, except as provided for in rule 39.9.1 below, appeal to the Jury of Appeal according to rule 39.9. Trophies or prizes which may be affected by a dispute will not be awarded until the Jury ruling has been given.
- 39.3.10 Should a target become unreasonably worn or otherwise disfigured, or should there be any other complaint about range equipment, a competitor or his/her Team Manager may appeal to the Judges to have the defective item replaced or remedied.

### 39.4 Order of Shooting and Timing Control

- 39.4.1 Competitors shall shoot in groups of no more than four (4), but never less than three (3). Should the number of competitors exceed the course capacity, additional groups shall be formed and placed on the course as convenient. Groups shall be assigned by drawing competitor names from a container, provided that there are no more than two competitors from one country in the same group. The group and target assignment will be made by the Organising Committee.
- 39.4.2 Competitors shall wear registration numbers and be allocated targets and shooting positions indicating the order of shooting in each group. Shooters shall be designated 1A, 1B, 1C, 1D, 2A, 2B, 2C, 2D, etc.
- 39.4.3 To give each competitor a chance to shoot at a clear target, each group shall shoot in the order rotating as follows
- 39.4.3.1 For a 4 competitor group 1st target A,B,C,D – 2nd target B,C,D,A – 3rd target C,D,A,B, - 4th target D,A,B,C and continue rotating for the remainder of the targets.
- 39.4.3.2 For a 3 competitor group A,B,C, - B,C,A – C,A,B and continue rotating for the remainder of the targets.
- 39.4.4 The shooting position shall be with both feet behind an imaginary straight line parallel to the target face, with one of the archer's feet within 50cm of the post. The imaginary line shall be 1 metre in length each side of the post and be parallel to the target.
- 39.4.5 Competitors shall shoot one (1) bolt at each target from the shooting peg.
- 39.4.7 Groups shall be assigned to start simultaneously from various targets and will complete the round at the target previous to one at which they started. Additional groups assigned to a target shall wait until the primary group on that target has shot and scored their bolts before proceeding. Groups shall be spaced out so as to avoid "bunching". Where there are more groups than target starting positions, the extra groups shall be queued on the last target and started by a Judge.
- 39.4.8 In the case of equipment failure, the order of shooting may be changed temporarily. In any event no more than one period of twenty (20) minutes in a days shooting shall be allowed to repair any equipment failure problem. The other competitors in the group shall shoot and score all their bolts in the Target before allowing any following groups to shoot through. If the repair is completed within the time limit, the competitor affected may make up any bolts remaining to be shot at that target.
- 39.4.9 Competitors in a group may allow other groups to "shoot through", provided that the Organisers or the Judges are notified.
- 39.4.10 A maximum time limit of two (2) minutes for **1 bolt** per target per competitor shall be allowed from the time the competitor takes his or her position at the peg, which he or she shall do as soon as it becomes available. Judges are required to time a competitor or a group who are causing undue delay in the competition. A Judge, having observed a competitor exceeding the time limit, shall caution him or her by a signed note on the scoresheet, indicating the time of the warning. For a second or subsequent warning during that stage of the competition, the competitor's highest scoring bolt at the target shall be forfeited.
- In exceptional circumstances the time limit may be extended by the Judges and/or Organising Committee.
- 39.4.11 Time warnings shall not be carried over from one stage of the competition to the next.

### 39.5 Targets and Distances

- 39.5.1 For the WCSA 3D Round animal figures with a minimum of two (2) critical/vital area scoring zones shall be used at unmarked distances (some targets have 3 vital scoring zones in which case the very inner zone will NOT be counted as extra score).
- 39.5.2 Targets should be positioned so they are distinguishable and the critical/vital area scoring zone unobstructed.
- 39.5.3 The animal figure scoring zones shall be that people with normal eyesight can see them clearly under normal daylight conditions at the relevant distances in the various target settings.
- 39.5.4 The target shall have an inner ring Critical scoring zone and a Vital scoring zone, the other scoring zone shall be the Body of the animal.
- 39.5.5 Targets not supplied grouped by the Manufacturer shall be grouped into numbered groups using the measurements listed in 39.5.6 and the method of measuring described below

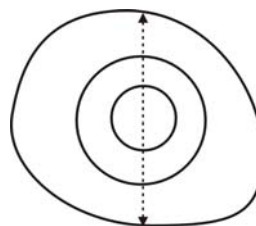

Take the measurement vertically through the centre of the scoring zones as indicated with the dotted line.

Compare this measurement with the measurements listed in 39.5.6 and group the target accordingly.

- 39.5.6 This table indicates the number of targets at each group size and the distance variations allowed for the course per 12 target unit. Double this for the WCSA 3D Round (24 Targets). The spacing between targets is not specified, but must be such as to maintain safety.

Number of Targets	Group Number	Scoring Zone Size	Distance variation in metres
2	4	0 - 150mm (0-5 <sup>7</sup> / <sub>8</sub> inches)	5 - 15
2	3	151 – 200mm (5 <sup>15</sup> / <sub>16</sub> inches)	10 - 25
4	2	201 - 250mm (7 <sup>27</sup> / <sub>32</sub> - 9 <sup>27</sup> / <sub>32</sub> inches)	20 - 35
4	1	251 + mm (9 <sup>7</sup> / <sub>8</sub> inches)	30 - 45

### 39.6 Shooting

- 39.6.1 Practice facilities shall be made available to all competitors at the ground before commencement of the event and conducted under safety control. The targets for practice may be butts with printed animal faces attached, set between the minimum (5m) and the maximum (45m) distances.
- 39.6.2 When a round is shot over several days there shall be practice facilities available at the commencement of each day.
- 39.6.3 A bolt shall not be deemed to have been shot if
- the competitor can touch it, or would be able to touch it if the ground was reasonably level, with his/her bow without moving his/her feet from their position in relation to the shooting peg, in which case another bolt may be shot in its place. If another bolt is not available the competitor may retrieve his/her bolt with the Judges' permission.
  - the target falls over. In this case, the Judges will take whatever measures they deem necessary and compensate adequate time for shooting the relevant number of bolts.  
Under no other circumstances shall a bolt be re-shot.
- 39.6.4 Shooters shall not discuss with one another the distances on the courses over the days of competition.
- 39.6.5 In the event of equipment failure the competitor shall step back off the shooting line (approx 0.5m) and call a Judge, the other competitors in the group should take a note of the time. The remainder of the group complete the shooting and scoring of that target then stand to one side and allow other groups to pass. The competitor will be allowed a maximum of 20 minutes from the time that they stepped back from the shooting line to make repairs and or replace broken equipment. Provided the repairs are completed within the 20 minutes they are then permitted to shoot any make up bolts on that target before moving to the next target with the group. Should the repair not be completed within the 20 minutes, the other competitors in the group may then continue shooting the next targets. When the repairs are completed the competitor may rejoin the group but cannot make up any targets missed. **Only one (1) equipment failure is permitted in a days shooting.**
- 39.6.6 A broken crossbow may be replaced with a spare, provided that it has been passed for equipment inspection. In such cases a Judge shall supervise the replacement or escort the shooter off the course, whichever is the quicker.
- 39.6.7 Except, as provided in clause 39.6.8 or in an emergency, no shooter shall leave the course until they have finished the round. Shooters shall take all necessary food, drinks and spare equipment with them.
- 39.6.8 In the event of a competitor being unable to continue shooting because of an unexpected medical problem which occurs after the beginning of the shoot, no more than 20 minutes will be allowed for medical personnel to determine the problem and decide whether or not the competitor is fit to continue competing unassisted.
- 39.6.9 Should a group be held up due to an equipment failure or medical problem they will complete that target, move to one side and allow other groups to pass until the problem has been rectified or the 20 minute time allowed has passed.
- 39.6.10 During the act of shooting, a competitor shall have some part of the body touching the shooting peg.

### 39.7 Scoring

- 39.7.1 Two competitors from each group shall be designated as scorers. These will normally be those shooters designated as A and B, and the score-sheets will be marked accordingly. Double scoring will be used.
- 39.7.2 Scoring shall take place at the target after all competitors in the group have shot their one (1) bolt.
- 39.7.3 Scorers shall enter on the score-sheet alongside the correct number of the target the value of each bolt as called out by the competitor to whom the bolt belong. Other competitors in the group shall check the value of each bolt called.
- 39.7.4 Scorers shall compare their scores before the bolts are drawn. A mistake on the score-sheet discovered before the bolts are drawn, may be corrected (refer clause 39.9.2).
- 39.7.5 Neither the bolts nor the target shall be touched until all bolts on that target have been recorded and scores checked.
- 39.7.6 A bolt shall be scored according to the position of the shaft in the target.
- 39.7.7 A bolt cutting or touching the line marking the edge of a higher scoring zone shall be awarded the score of the higher zone
- 39.7.8 The inner ring known as the Critical Scoring Zone shall score ten (10) points.
- 39.7.9 The outer ring known as the Vital Scoring Zone shall score eight (8) points.
- 39.7.10 The rest of the Body of the Animal (not including horns, antlers, hooves) shall score five (5) points, providing the bolt is held in the target.

39.7.11

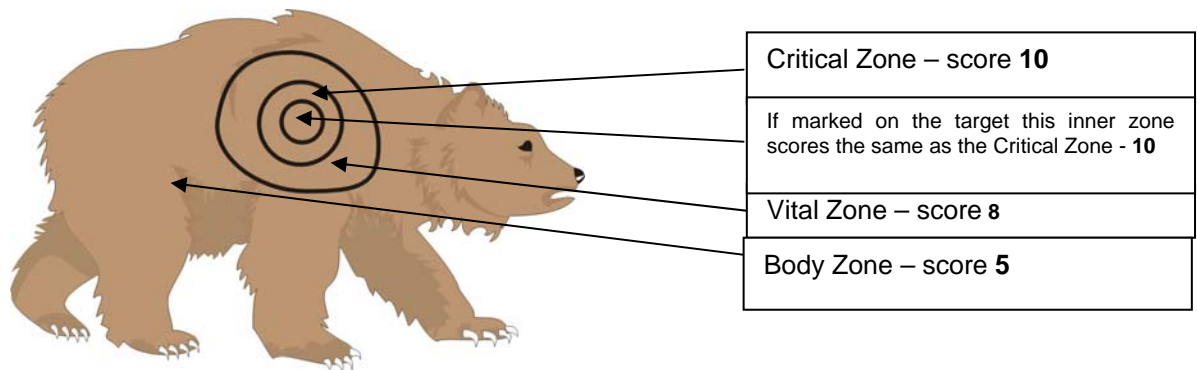

39.7.12 Should a fragment of the target scoring zone line be missing then an imaginary continuation of the line shall be used for judging the value any bolt which may hit that part.

39.7.13 Bolts completely imbedded in the buttress and not showing on the scoring side can only be scored either by a Judge or

the total agreement of all the competitors in the group. In the scoring by all the competitors they must all initial the score sheet stating their agreement to the score given.

39.7.14 Bolts rebounding from or passing completely through the buttress shall only be scored as follows:

39.7.14.1 If the majority of competitors in the group agree on the value of the bolt that has rebounded from or passed through, that bolt shall be scored as the agreed value.

39.7.14.2 If the majority of the competitors in the group cannot agree that a bolt has rebounded or passed through or cannot agree on its value, then that bolt shall be scored as a miss or a judge may be called for an independent decision.

39.7.15 A bolt hitting:

39.7.15.1 Another bolt and remaining imbedded therein, shall score according to the value of the struck bolt.

39.7.15.2 Another bolt, and then hitting the target after deflection, shall score as it lies in the target.

39.7.15.3 Another bolt, and then rebounding, shall score the value of the struck bolt, provided that the damaged bolt can be identified.

39.7.15.4 A target other than the competitor's own target, shall not score.

39.7.16 **Score Validation:** At the completion of the course, score-sheets shall be signed by the scorers and the competitor, denoting that the competitor agrees with the values of each bolt. If the scorer is participating in the shooting, his/her score sheet shall be signed by another competitor in the same group. Competitors are responsible for the verification of their own score-sheets. Score-sheets shall be legible and complete. Duplicates shall not be issued for any lost, damaged or stolen score-sheets. Once the score-sheets have been handed in, they will not subsequently be changed. Any disagreement in scoring values between the score-sheets shall be recorded at the lower value.

39.7.17 Any shooter who alters or knowingly falsifies a score-sheet without authorisation shall be disqualified

## 39.8 Ties

39.8.1 In the event of a tie in score, the results shall be determined in the following order:

39.8.1.1 **For individuals:**

- a) The competitor, of those tying, with the greatest number of scoring hits.
- b) If this is also a tie, then the competitor of those so tying with the greatest number of hits scoring ten (10) points.
- c) If this is also a tie, then the competitors so tying shall be declared equal.

39.8.1.2 **For Teams:**

- a) The team, of those tying, having the competitor making the highest individual score.
- b) If this is also a tie, then the team of those so tying having the competitor making the second highest individual score.
- c) If this is also a tie, then the teams so tying shall be declared equal.

## 39.9 Questions, Disputes and Appeals

39.9.1 Any competitor may, if deemed necessary, refer any questions about the value of a bolt in the target to a Judge before any bolts are drawn. The ruling of that Judge shall be final. The competitor may not hold up the shooting unnecessarily.

39.9.2 A mistake on a score-sheet may be corrected before the bolts are drawn, provided that all competitors on the target agree on the correction. The correction shall be witnessed and initialled by all the competitors on the target. Any other disputes concerning entries on a score-sheet shall be referred to a Judge.

39.9.3 Should it be discovered that:

- a) the size of a target has been changed during the competition, or,
- b) the position of a shooting post has been moved after shooters have already shot the target, or,
- c) the target is or has become un-shootable for certain arbalists because of hanging branches, or other obstructions,

that target shall be eliminated for the purpose of scoring for all competitors of the division involved, should an appeal

be upheld. If one or more target(s) is disqualified, the remaining targets will be considered to constitute a full Round.

- 39.9.4 Should a target become unreasonably worn or otherwise disfigured or should there be any other complaint about course equipment, a competitor or his Team Manager may appeal to the Judges' Commission before the next stage of the competition.
- 39.9.5 Questions concerning the conduct of the shooting or the conduct of a competitor shall be lodged with the Judges before the next stage of the competition.
- 39.9.6 Questions regarding the daily published results shall be lodged without undue delay, and in any event must be lodged in time to allow corrections to be made before the prize giving.
- 39.9.7 In the event of a competitor not being satisfied with a ruling given by the Judges, he or she may, except as provided for in clause 39.9.1 above, appeal through his or her Team Manager to the Jury of Appeal, in writing, before the beginning of the next stage of the competition. Trophies or prizes which may be affected by a dispute shall not be awarded until after the Jury has ruled on the dispute.

### 39.10 Jury of Appeal

*For World Championships refer to Section 1, Clause 20,*

- 39.10.1 A Jury of Appeal of three members shall be appointed by the Organising Committee. Persons participating in the Championships are not eligible for the Jury of Appeal. Members of the Jury of Appeal shall preferably be persons with experience and a good knowledge of the sport and rules. Where a Jury of Appeal has not been appointed, the Organising Committee shall assume this role.
- 39.10.2 Appeals must be presented, in writing, by Team Managers, or appellants if no Team Manager has been designated or they are individual member competitors. No appeal can be made against the value of a bolt. An intention to appeal when it might affect the progression of a competitor from one stage of the competition to the next must be expressed in writing and lodged with the chairperson of the Tournament Judge Commission within **15** minutes of the end of that stage. The written appeal must be lodged with the Jury in time to allow the Jury to come to a decision before the beginning of the next stage of the competition.
- 39.10.3 The Jury must be available at the Tournament grounds at all times during the Tournament or event (including the day of official practice) until thirty minutes after the end of shooting.
- 39.10.4 Jury decisions shall be minuted and submitted to the appellant, the Chairperson of the Tournament Judge Commission and the Organising Committee before the beginning of the next stage of the competition or before the awarding of prizes. The ruling of the Jury of Appeal shall be final.
- 39.10.5 **Protest Fee**  
All appeals must be submitted in writing not later than one hour after the close of the days shooting unless it affects the next stage of a competition (see 39.10.2) and before any prize giving and be accompanied by a fee if one is applied by the Organising Committee (for World Championships Refer to Section 1, Clause 20, Page 1-8). The fee applied shall be returned if the appeal is upheld and shall be retained by the Organising Committee if the appeal is lost.
- 39.10.6 Decisions made by the Jury of Appeal must be documented and submitted to the appellant, the Chairman of the Judges Commission and the Chairperson of the Organising Committee before the awarding, of prizes or the next stage of the competition as the case may be. This terminates the path of appeal.

### 39.11 Course Director

- 39.11.1 The Chairman of the Judges Commission will be in overall command of the 3D Round Course on the days of the competition.
- 39.11.2 Their responsibilities are.
  - a) To ensure the Safety for both competitors and spectators
  - b) To organise getting competitors to their starting target as allocated by the Organising Committee
  - c) To organise and control the Judges Commission
  - d) To start the shooting
  - e) To address the competitors on any necessary items before they go on the course.

### 39.12 Judges

- 39.12.1 The Judges' duties are to ensure that the tournament is conducted according to the World Crossbow Shooting Association Constitution & Rules, and in fairness to all competitors.
- 39.12.2 Where possible at least one Judge for every 6 target butts in the 3D Round will be appointed. However there must always be a minimum of three judges. Their duties will be as follows:
  - 39.12.2.1 They will;
    - a) check all distances and the correct layout of the course;
    - b) check the dimensions of targets;
    - c) check that the correct size and group targets are installed for the correct distances,.
    - d) check that all targets are set at the correct angle.
    - e) check all the necessary venue equipment;
    - f) check all competitors' equipment before the Tournament (time to be stated on the tournament program) and at any time thereafter during the Tournament,
    - g) control the conduct of the shooting;
    - j) to handle any disputes and appeals which may arise and, where appropriate, pass them on to the Jury of Appeal;
    - k) in liaison with the Organising Committee, interrupt the shooting if necessary, because of weather conditions, a serious accident, or other occurrences, but to ensure if at all possible, that each

day's program is completed on that day,

- l) consider relevant complaints or requests from Team Managers and where applicable to take suitable action. Collective decisions will be made by a simple majority of votes. In case of a tie, the Chairman will have a tie-breaking vote;
- m) deal with questions concerning the conduct of the shooting or the conduct of a competitor. These questions must be lodged with the Judges without any undue delay and in any event must be lodged before the prize giving. The ruling of the Judges or Jury of Appeal, as applicable, will be final.
- n) make sure that at no time will any equipment failure delay the tournament by more than **20** minutes.
- o) control that all competitors and officials conform with the World Crossbow Shooting Association Constitution and Rules as well as decisions and directives the Judges may find necessary to make. A competitor proved to have transgressed any rules and regulations knowingly may be ruled to be not eligible to participate and be eliminated and will lose any position he/she may have gained.

# **SECTION SIX**

## **Appendix/Diagrams**

**APPENDIX 1 – TYPICAL MEDIEVAL CROSSBOW**



**APPENDIX 2 SAMPLE MEDIEVAL TYPE TRIGGER**

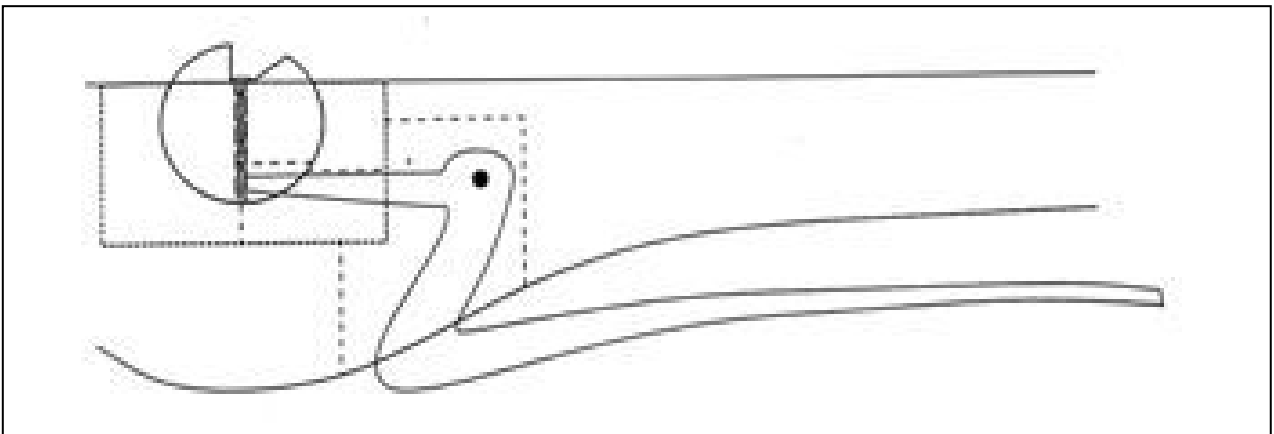

**APPENDIX 4 - RECOMMENDED GROUND LAYOUT FOR WORLD OUTDOOR TARGET CHAMPIONSHIPS**

**CHAMPIONSHIPS**

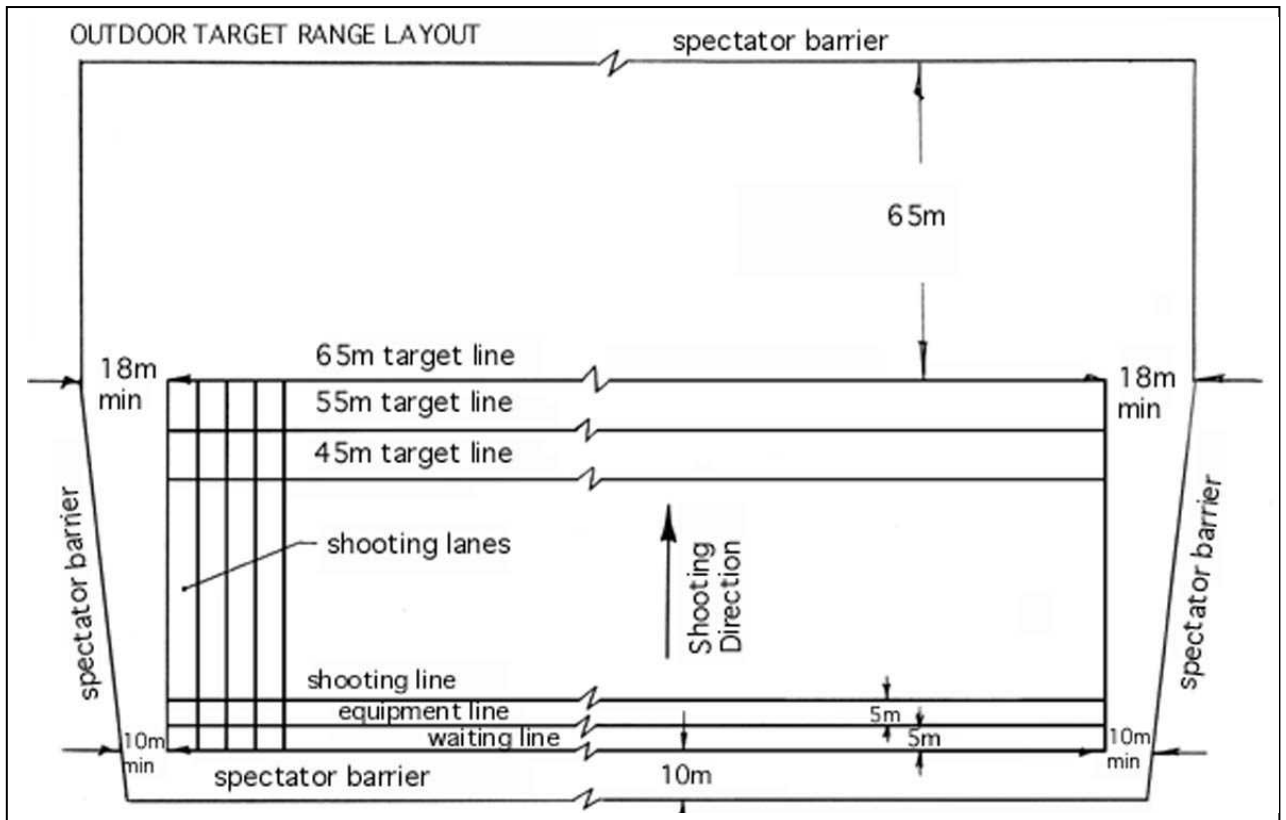

**APPENDIX 5 - TARGET BUTT**

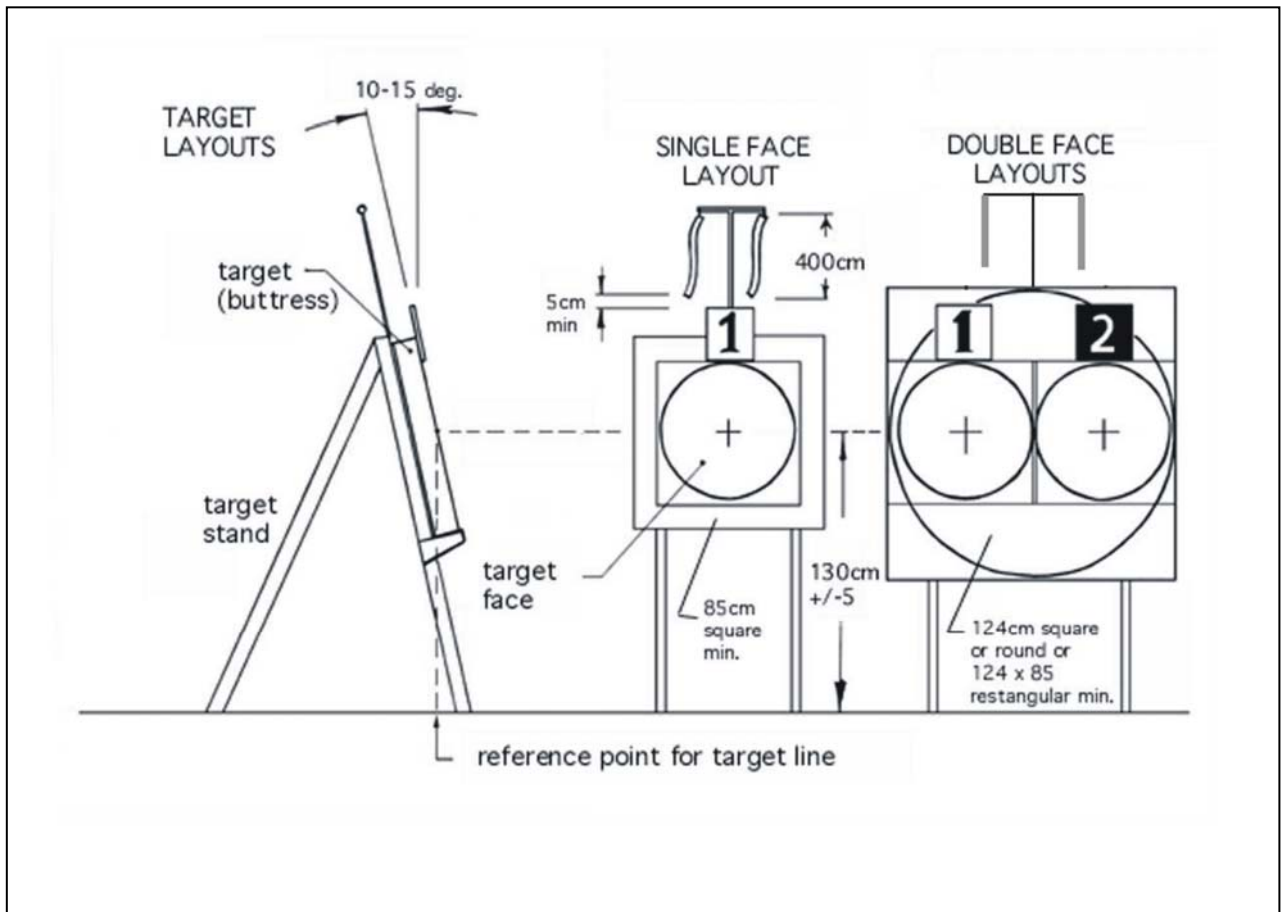



**APPENDIX 6 - WIND INDICATORS**

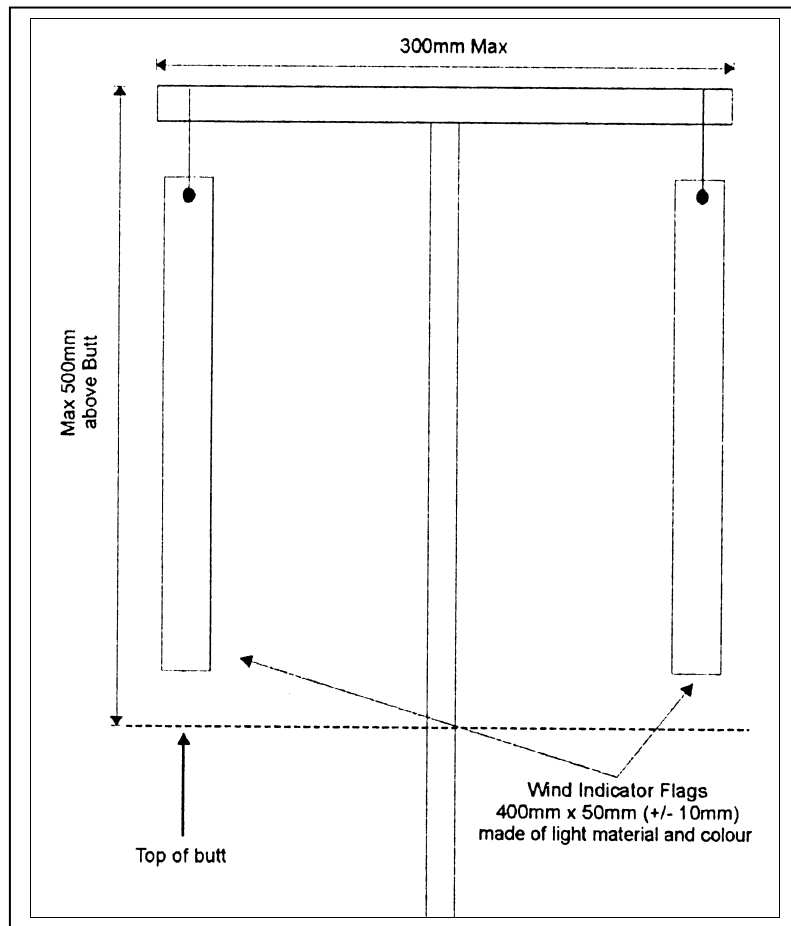

**APPENDIX 7 - 30 SECOND TIMER PLATES**

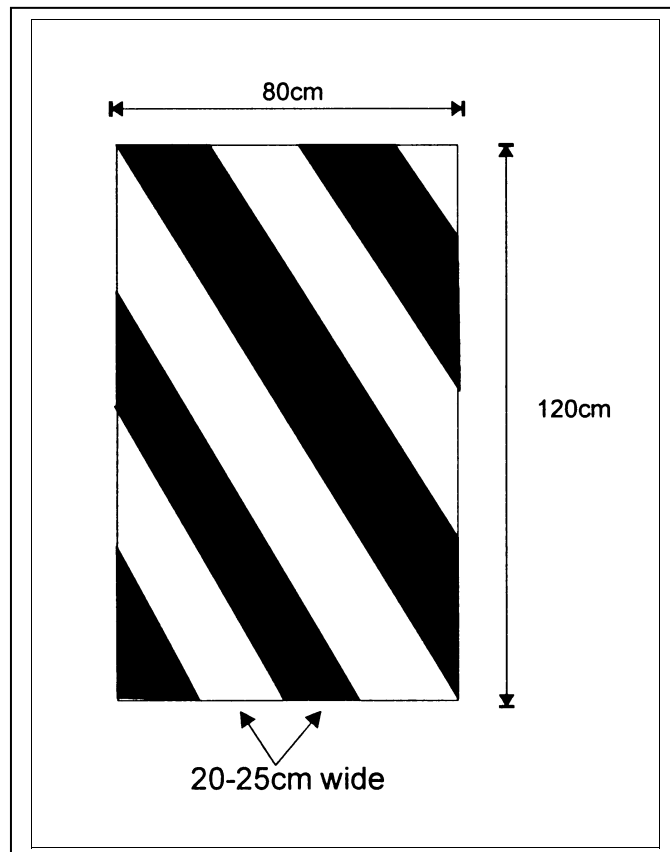

**APPENDIX 8 - TARGET FACES**

**Multi-coloured**

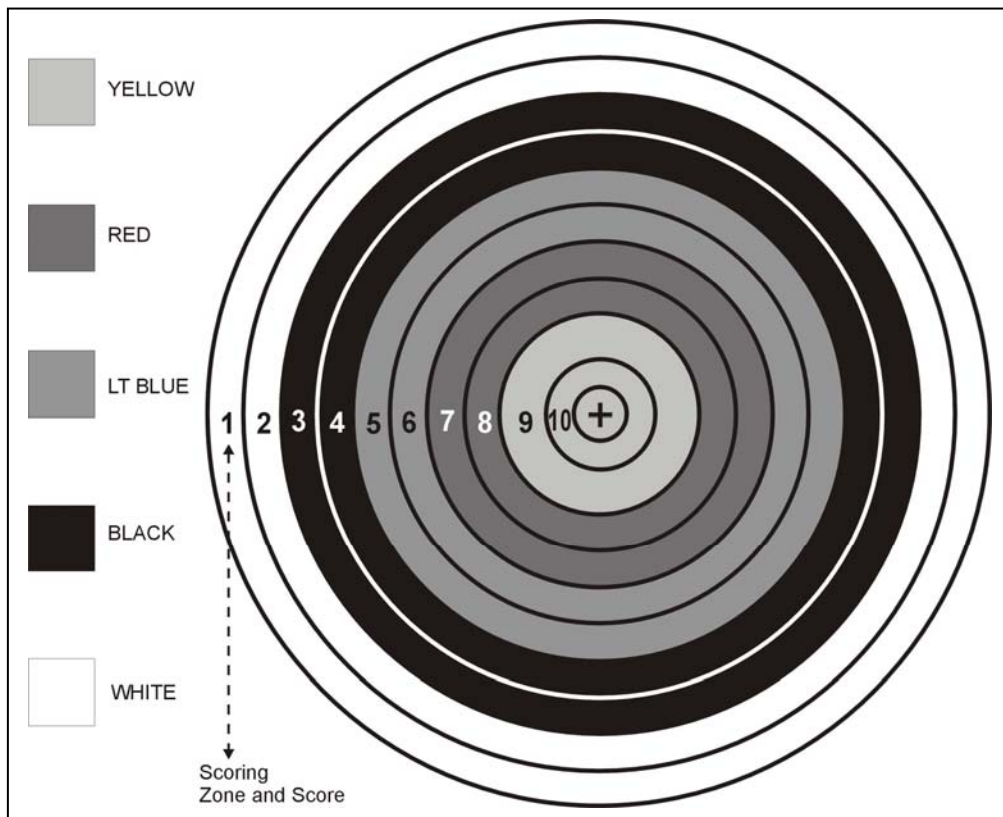

**APPENDIX 9 - RECOMMENDED WORLD CHAMPIONSHIP OUTDOOR MATCH-PLAY GROUND LAYOUT.**

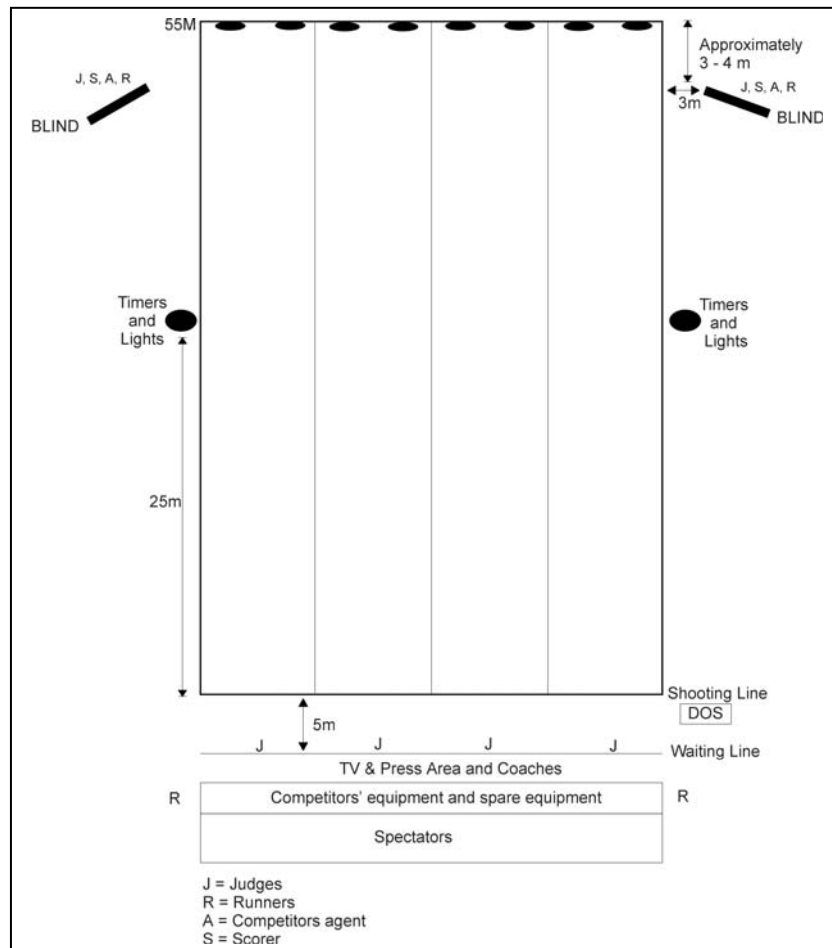

**APPENDIX 10 - MATCH-PLAY SEEDING CHART**

**MATCHPLAY CHART (16 Competitors)**

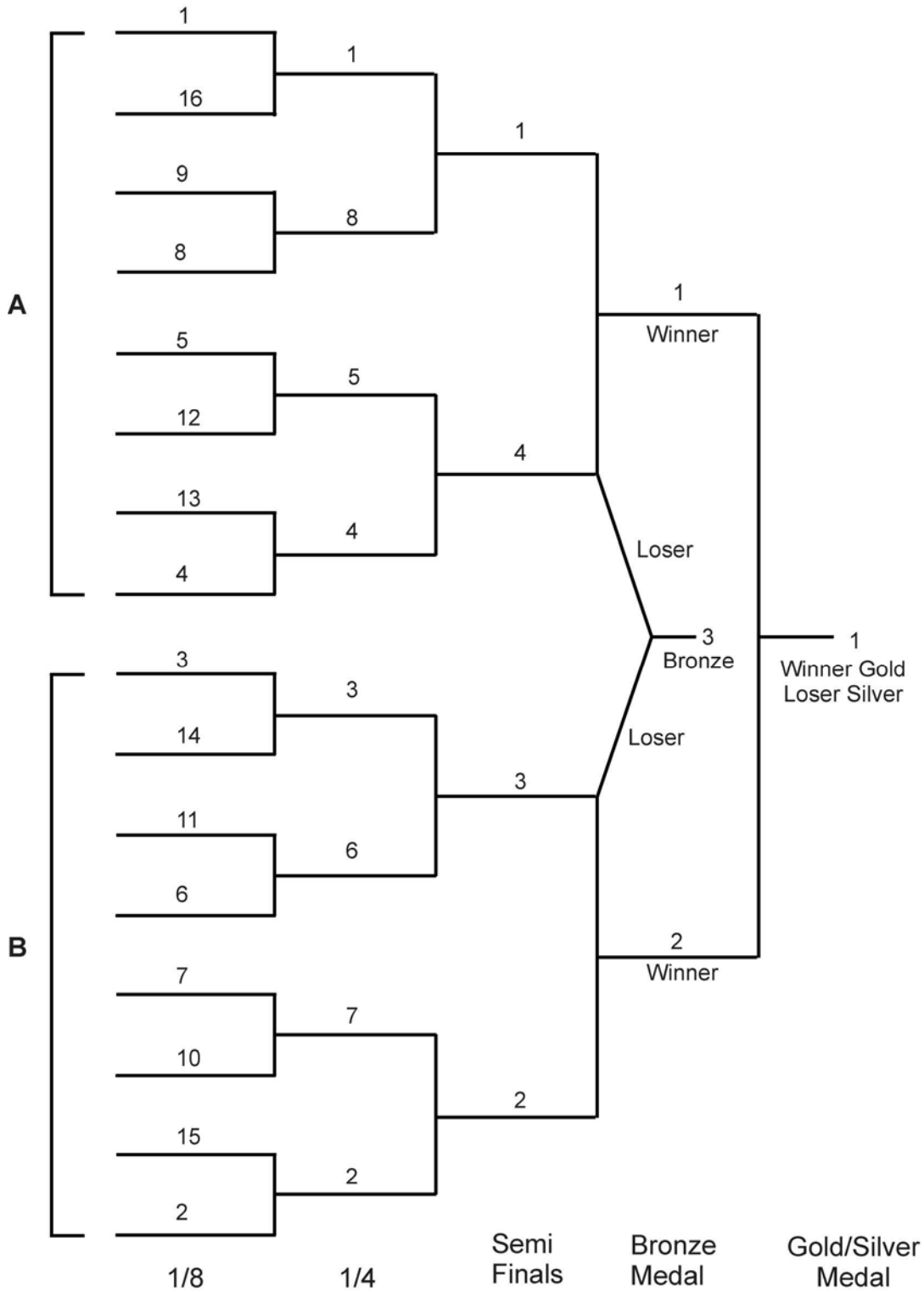

Order of shooting with 4 targets (2 competitors per target) = Group **B** first then Group **A**

Winner of each match moves along line to next match - Loser drops out.

Winners of Semi Finals shoots for Gold/Silver Medals - Losers shoot for Bronze Medal

**APPENDIX 11 - SUPPORT STAND (PICTURE)**



**APPENDIX 12 - SUPPORT STAND (DIAGRAM)**

